



US006001248A

United States Patent [19]

[11] Patent Number: 6,001,248

Leddy et al.

[45] Date of Patent: Dec. 14, 1999

[54] GRADIENT INTERFACE MAGNETIC COMPOSITES AND SYSTEMS THEREFOR

5,241,447 8/1993 Barber et al. 361/141
5,646,001 7/1997 Terstappen et al. 436/526

[75] Inventors: Johna Leddy; Sudath Amarasinghe, both of Iowa City, Iowa; Lois Anne Zook, Richmond, Ohio

OTHER PUBLICATIONS

Burstall, F.H. and Nyholm, R.S., Studies in Co-ordination Chemistry. Part XIII. Magnetic Moments and Bond Types of Transition-metal Complexes, *J. Chem. Soc.* pp. 3570-3579 (1952).

[73] Assignee: The University of Iowa Research Foundation, Iowa City, Iowa

Cotton, F.A. and Wilkinson, G., *Advanced Inorganic Chemistry*, Third Edition, Interscience Publishers, New York, 1972, pp. 329, 369.

[21] Appl. No.: 08/486,570

Figgis, B.N. and Lewis, J., The Magnetic Properties of Transition Metal Complexes, in *Progress in Inorganic Chemistry*, vol. 6, Cotton, F.A., ed., Interscience Publishers, New York, 1964, pp. 37-239.

[22] Filed: Jun. 7, 1995

Related U.S. Application Data

Primary Examiner—David A. Reifsnnyder
Attorney, Agent, or Firm—Fleshner & Kim

[63] Continuation-in-part of application No. 08/294,797, Aug. 25, 1994, abandoned.

[51] Int. Cl.⁶ B01D 35/06

[57] ABSTRACT

[52] U.S. Cl. 210/222; 210/175; 210/695; 428/692

Magnetic composites exhibit distinct flux properties due to gradient interfaces. The composites can be used to improve fuel cells and batteries and effect transport and separation of different species of materials, for example, transition metal species such as lanthanides and actinides. A variety of devices can be made utilizing the composites including a separator, an electrode for channeling flux of magnetic species, an electrode for effecting electrolysis of magnetic species, a system for channeling electrolyte species, a system for separating particles with different magnetic susceptibilities, improved fuel cells, batteries, and oxygen concentrators. Some composites can be used to make a separator for distinguishing between two species of materials and a flux switch to regulate the flow of a chemical species. Some composites can control chemical species transport and distribution. Other composites enable ambient pressure fuel cells having enhanced performance and reduced weight to be produced. Still other composites enable rechargeable batteries to be made that have longer secondary cycle life and improved output power. Methods involving these composites provide distinct ways for these composites to be utilized.

[58] Field of Search 210/222, 223, 210/695, 175; 204/279, 280, DIG. 85, 194; 428/692, 900, 928

[56] References Cited

U.S. PATENT DOCUMENTS

3,945,910	3/1976	De Ceuster et al.	204/296
4,201,827	5/1980	Heitkamp .	
4,244,998	1/1981	Smith	156/95
4,247,398	1/1981	Mohri	210/222
4,293,371	10/1981	Kokta et al. .	
4,339,337	7/1982	Tricot et al. .	
4,647,514	3/1987	Le Craw et al.	428/692
4,725,490	2/1988	Goldberg .	
4,795,698	1/1989	Owen et al.	436/526
4,965,007	10/1990	Yudelson	252/62.53
4,973,391	11/1990	Madou et al. .	
5,075,169	12/1991	Nagai et al.	428/402
5,096,551	3/1992	Schoen et al. .	
5,102,745	4/1992	Tatarchuk et al.	428/605
5,172,751	12/1992	Croat	148/101
5,186,854	2/1993	Edelstein	252/62.55
5,187,034	2/1993	Otagawa et al.	429/198

33 Claims, 40 Drawing Sheets

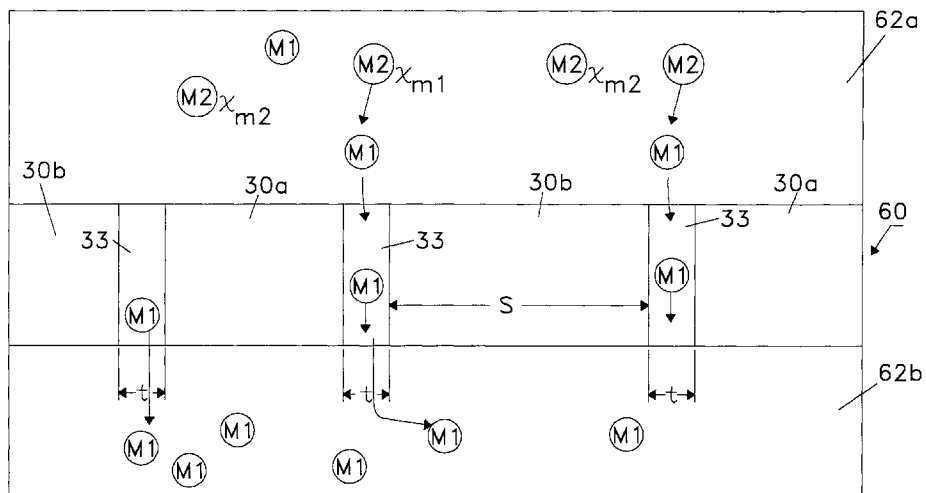

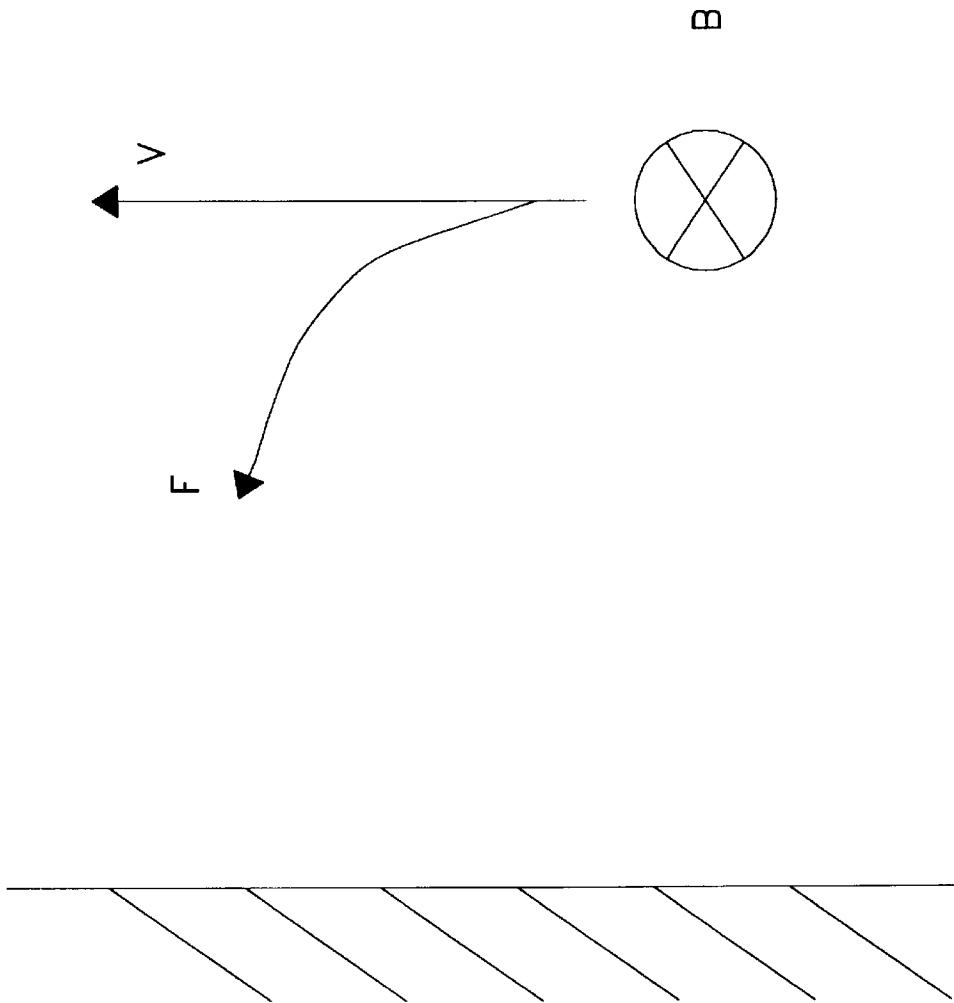

Figure 1

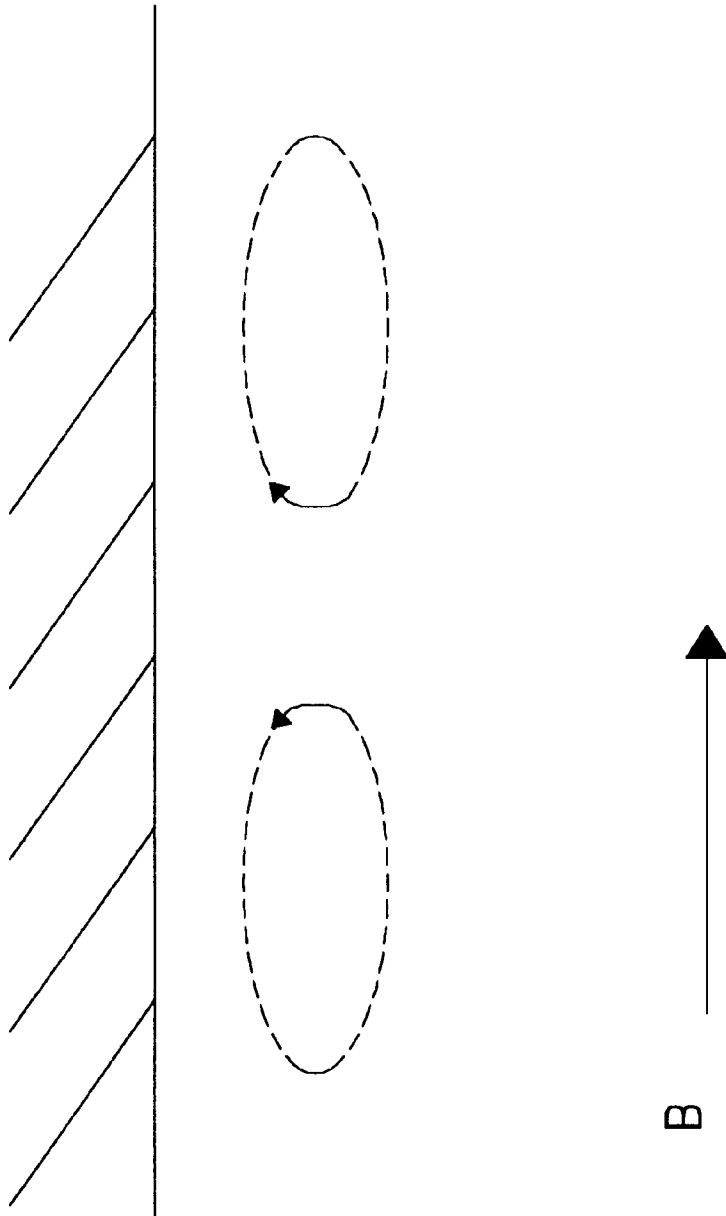

Figure 2

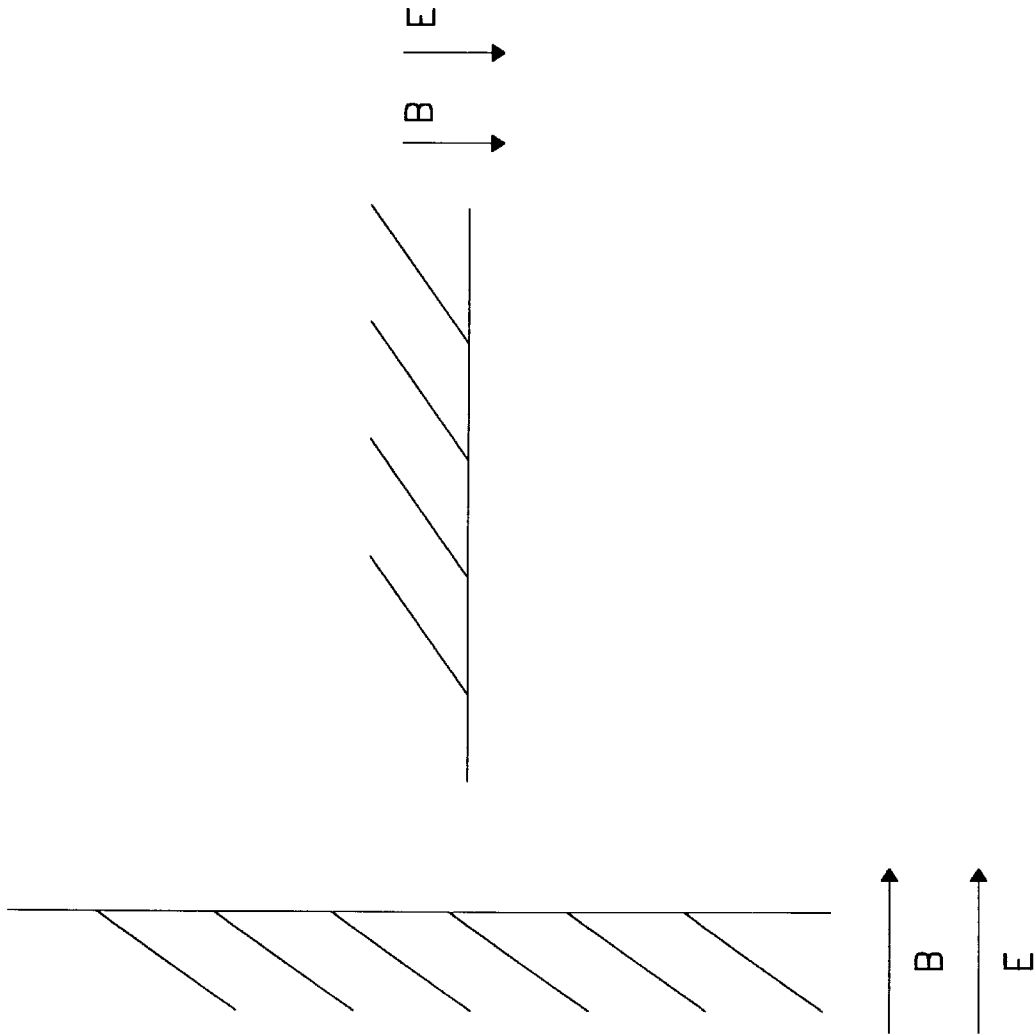

Figure 3

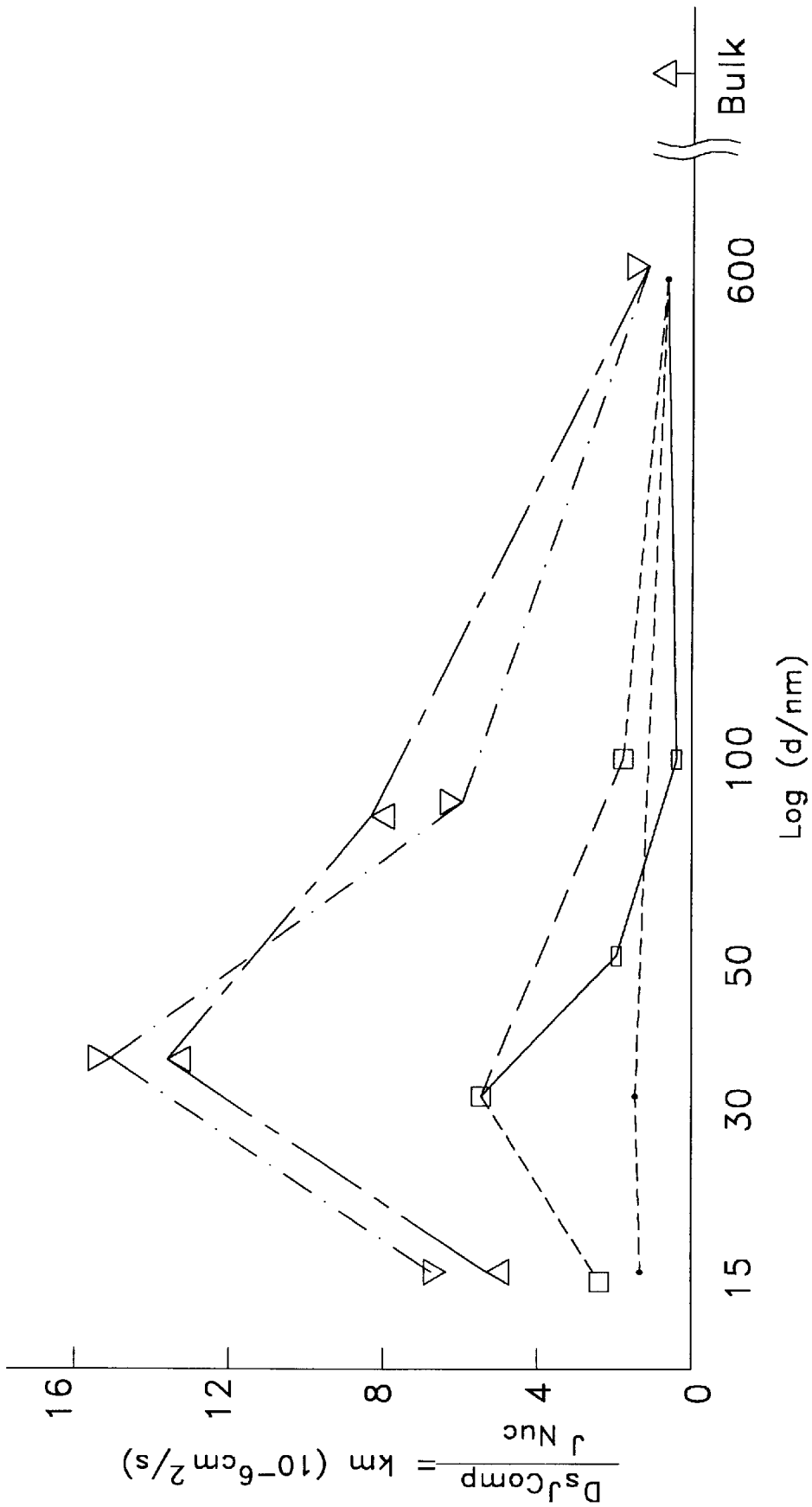

Figure 4A

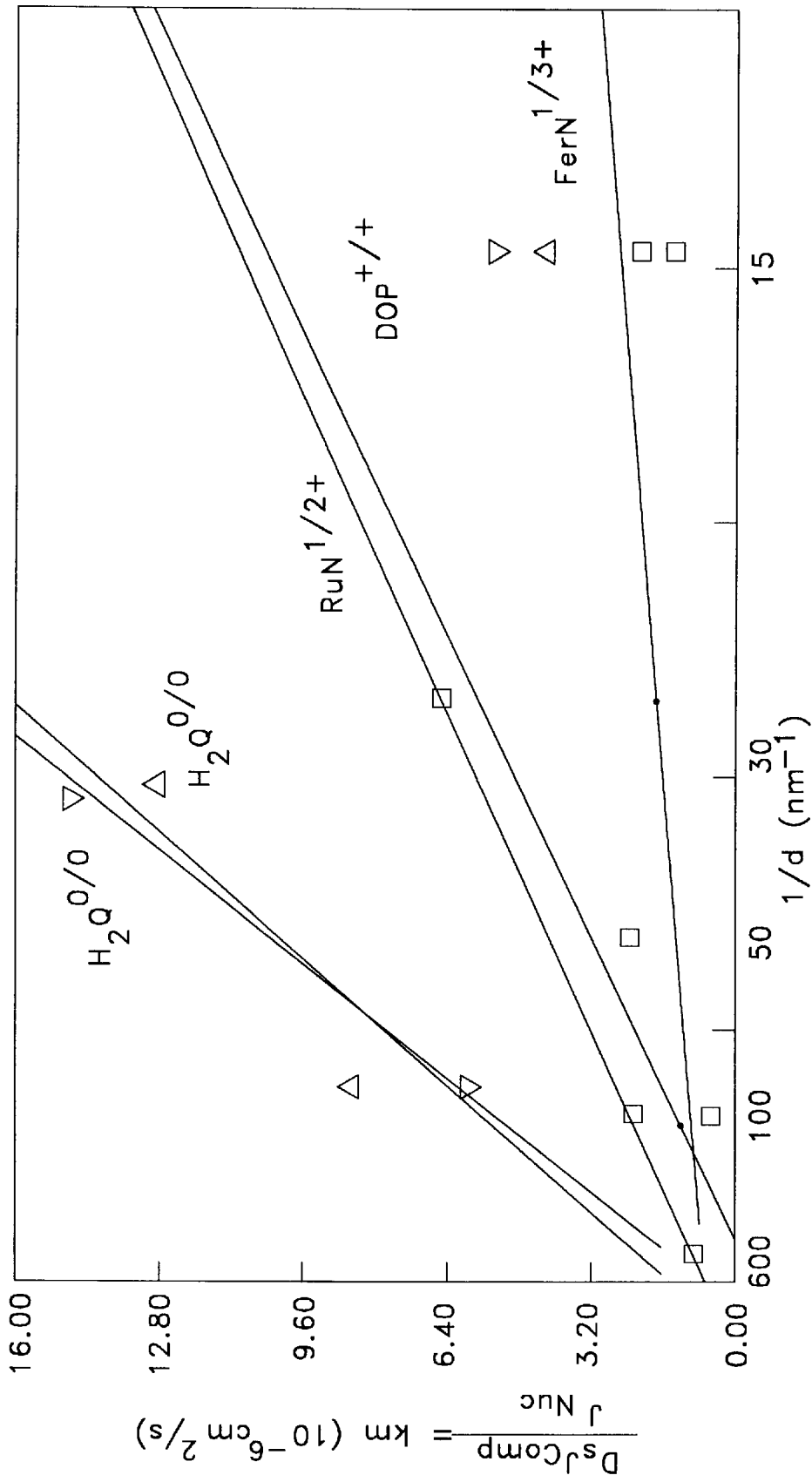

Figure 4B

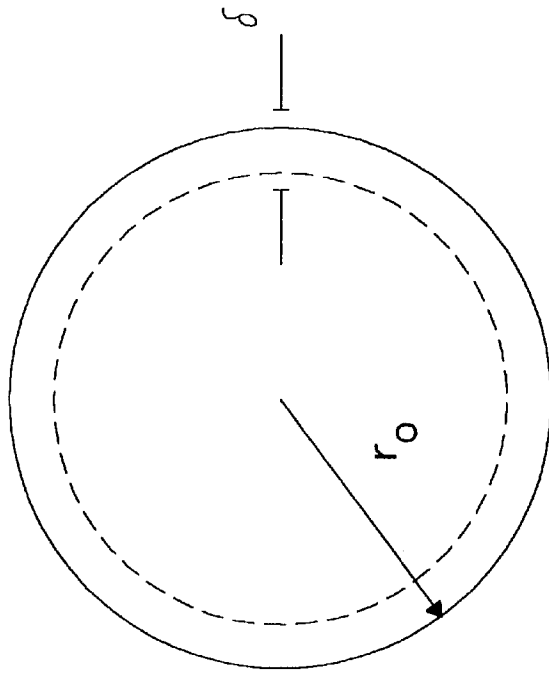

Figure 5B

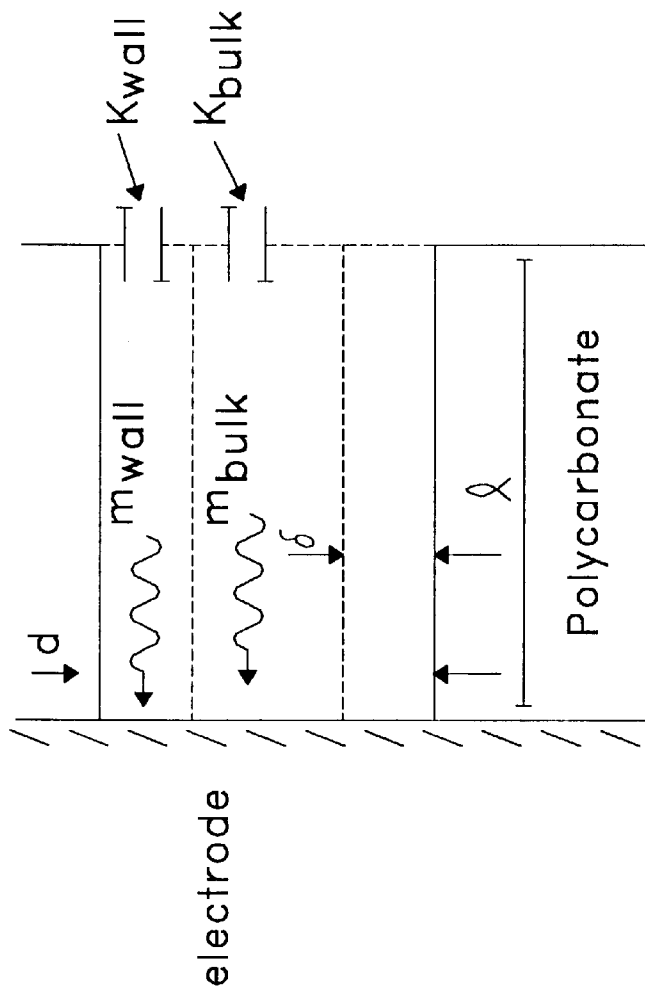

Figure 5A

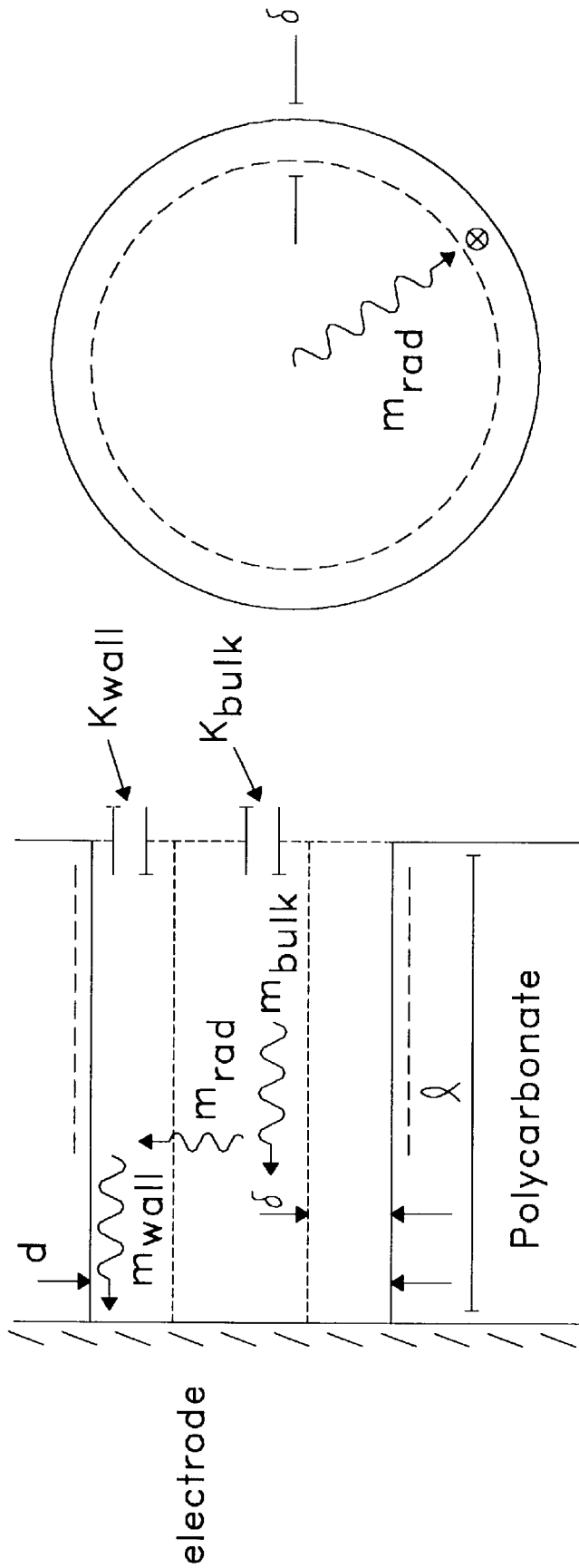

Figure 6B

Figure 6A

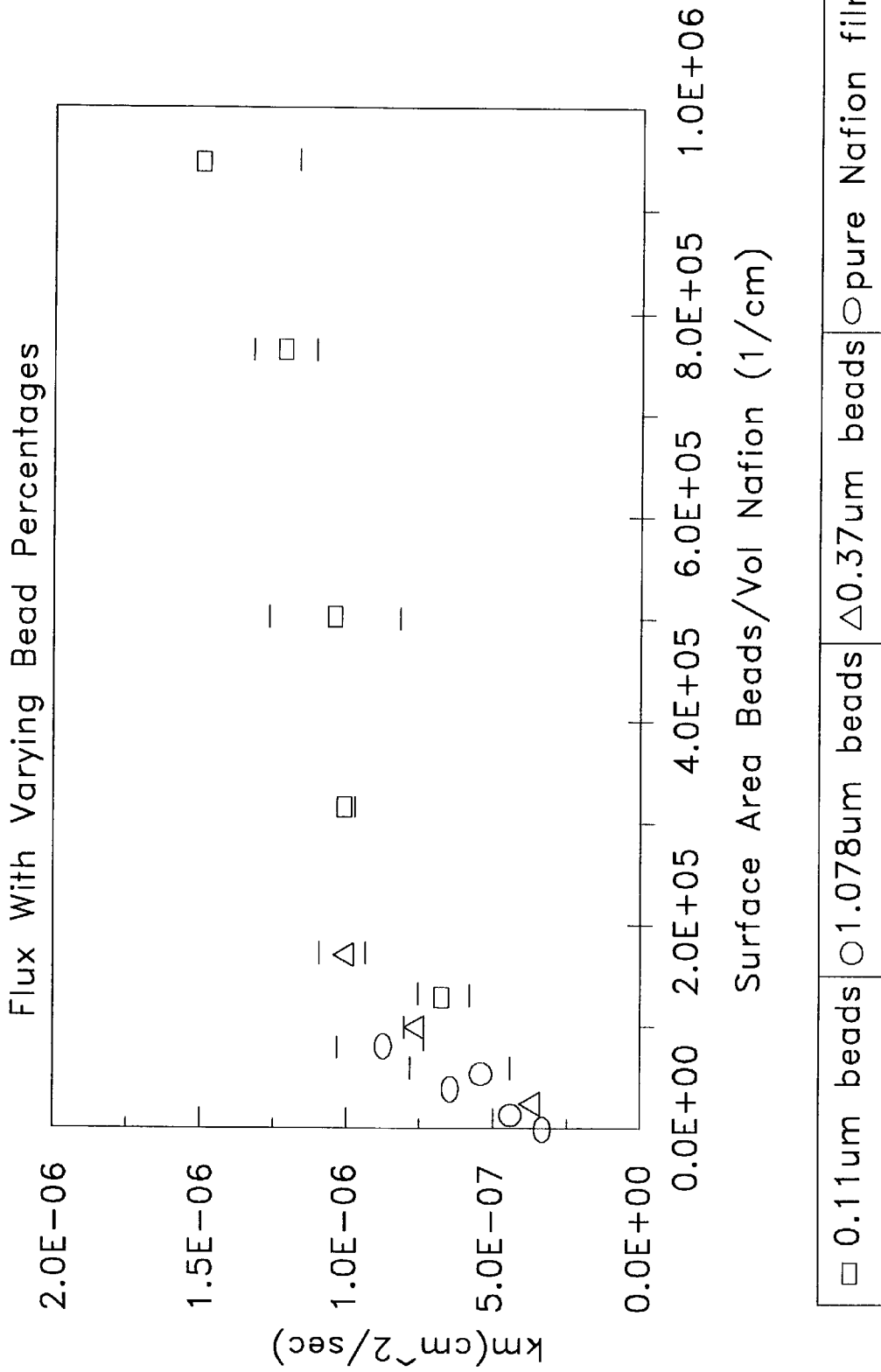

Figure 7A

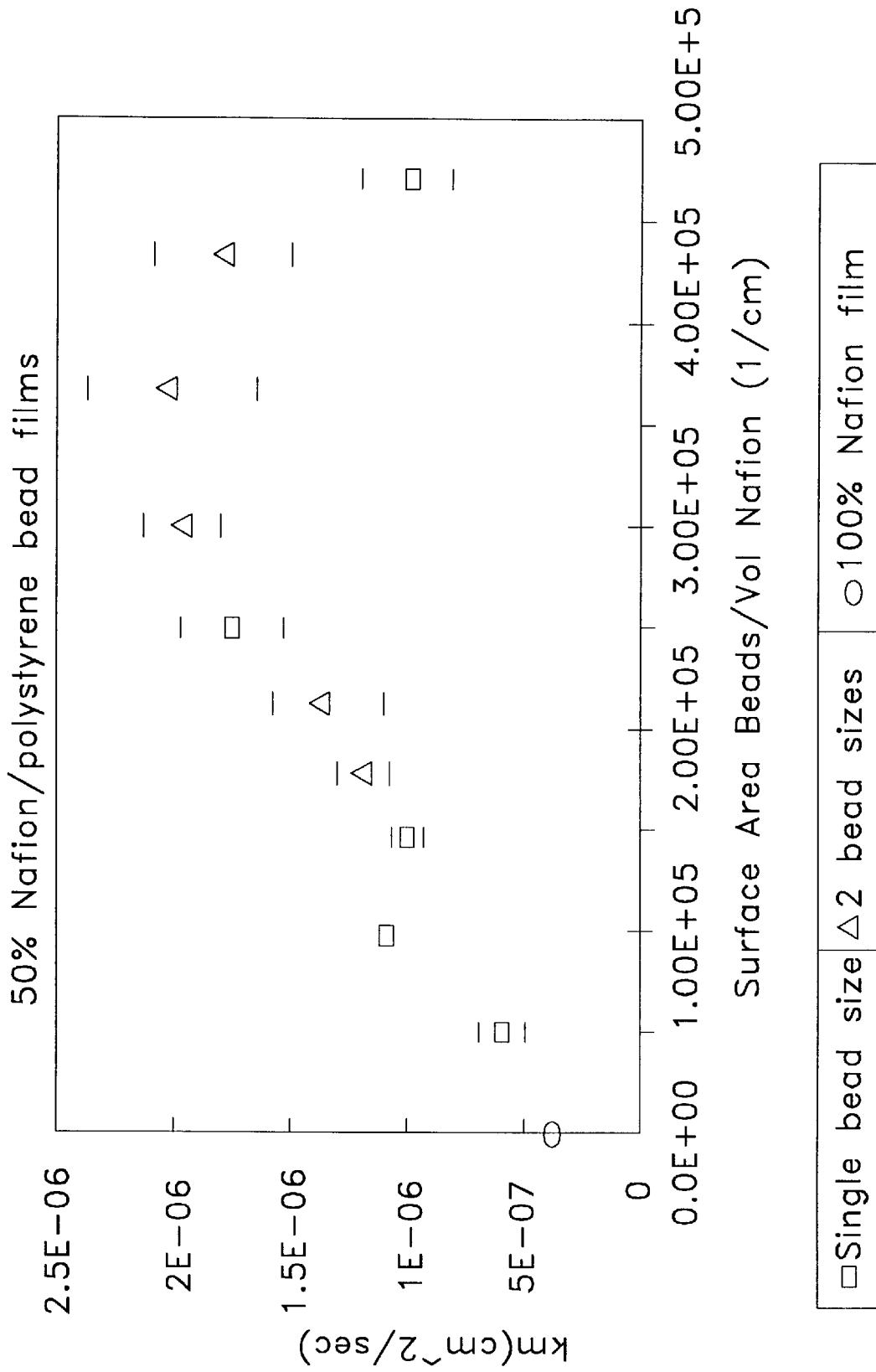

Figure 7B

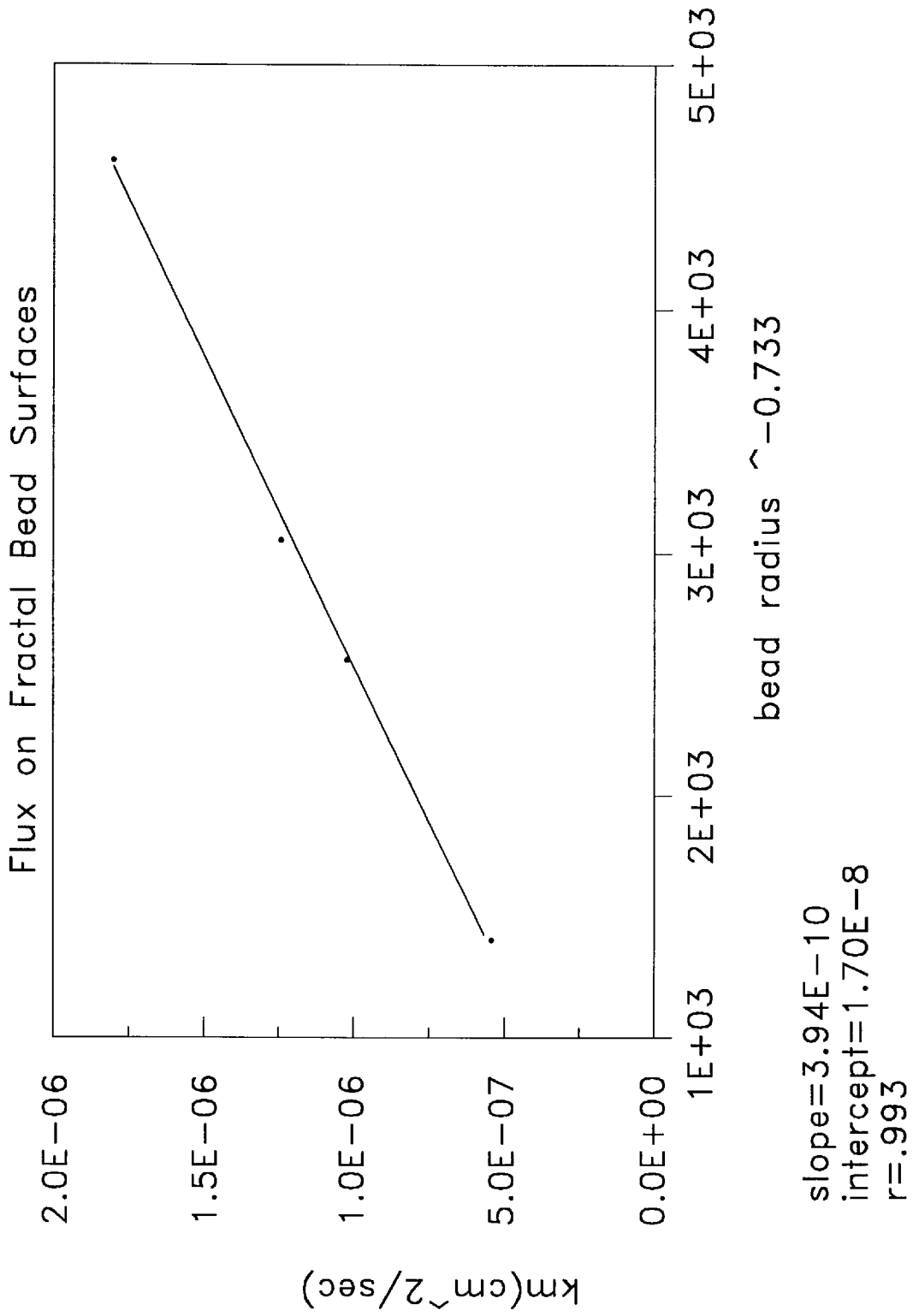

Figure 8

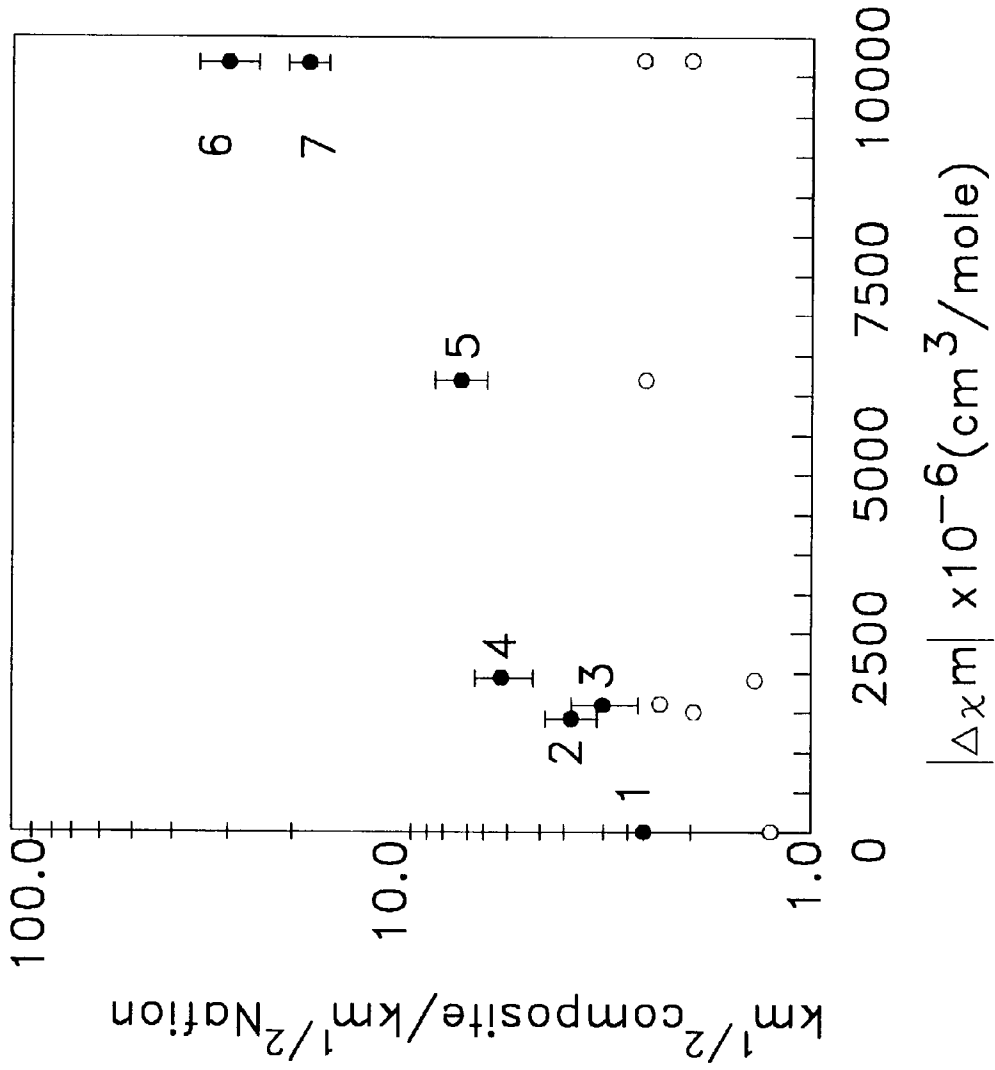

Figure 9

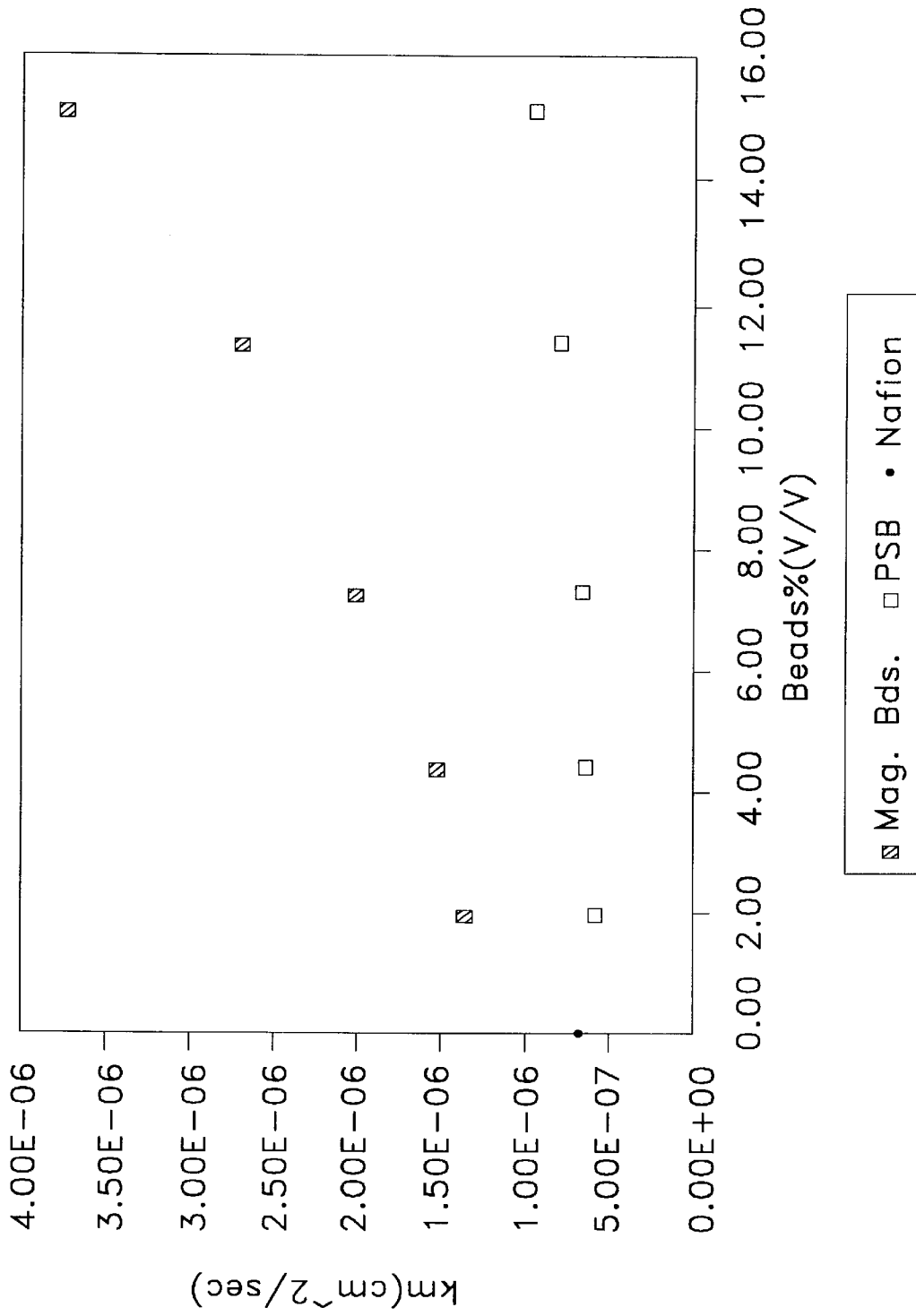

Figure 10

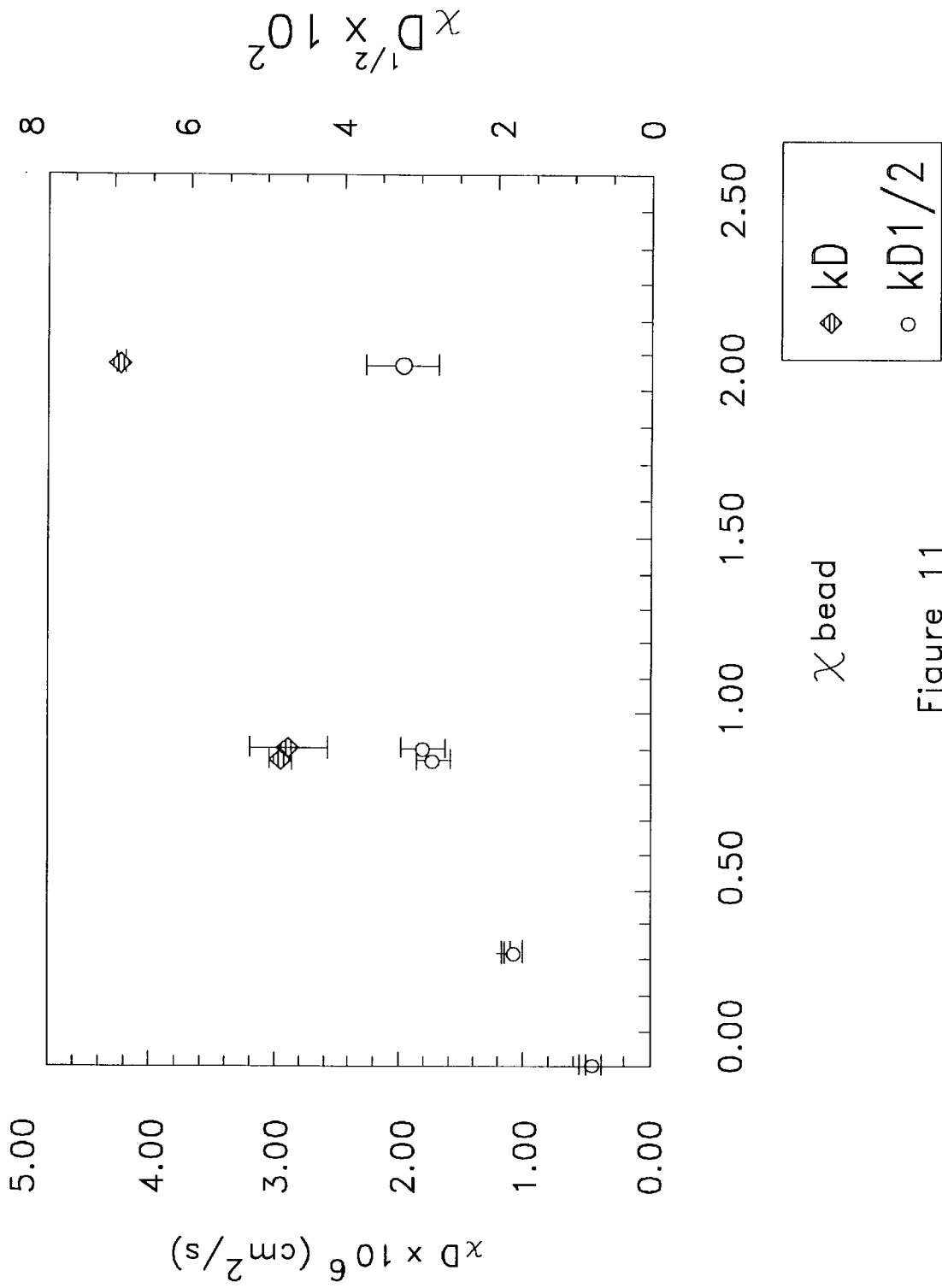

Figure 11

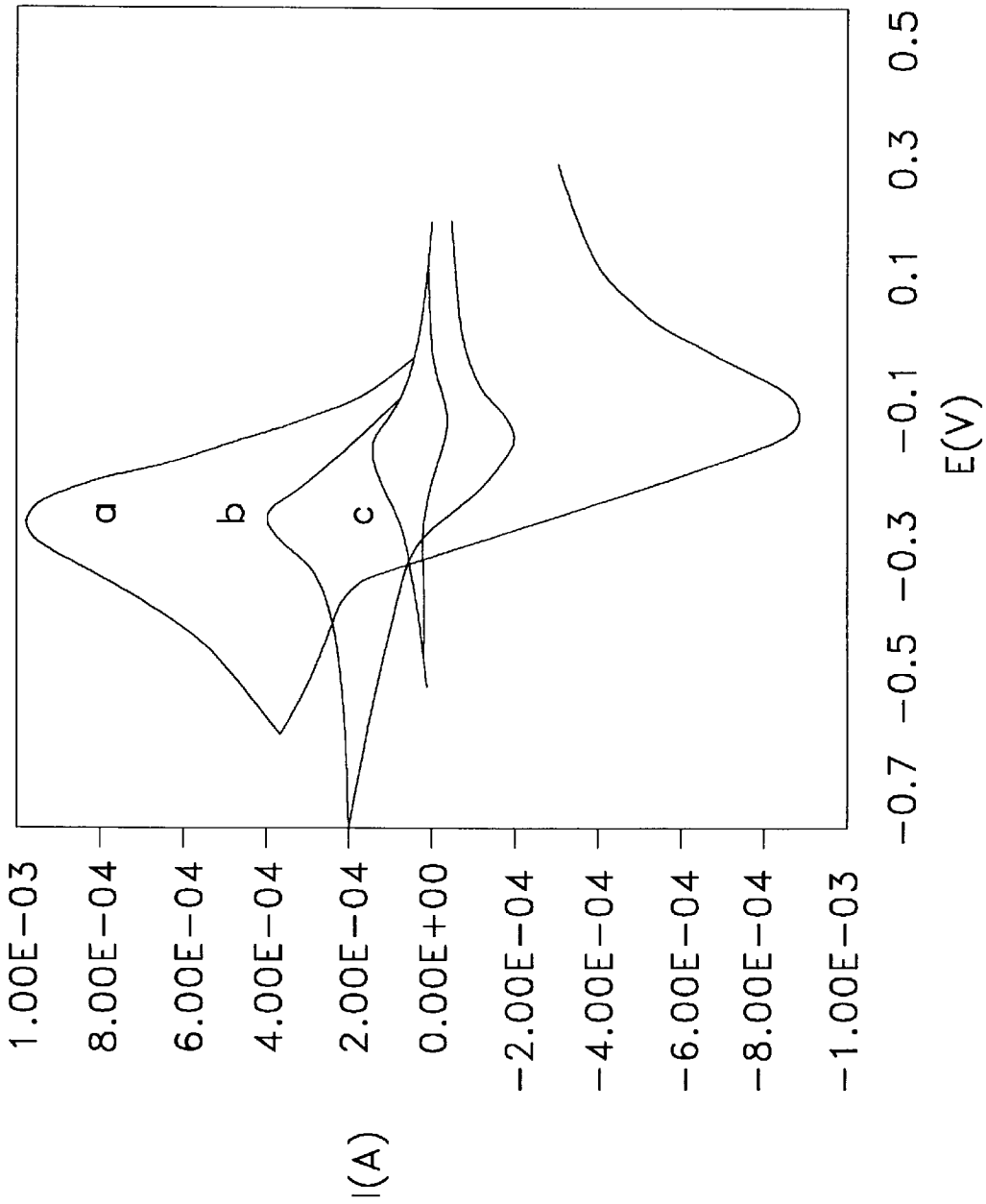
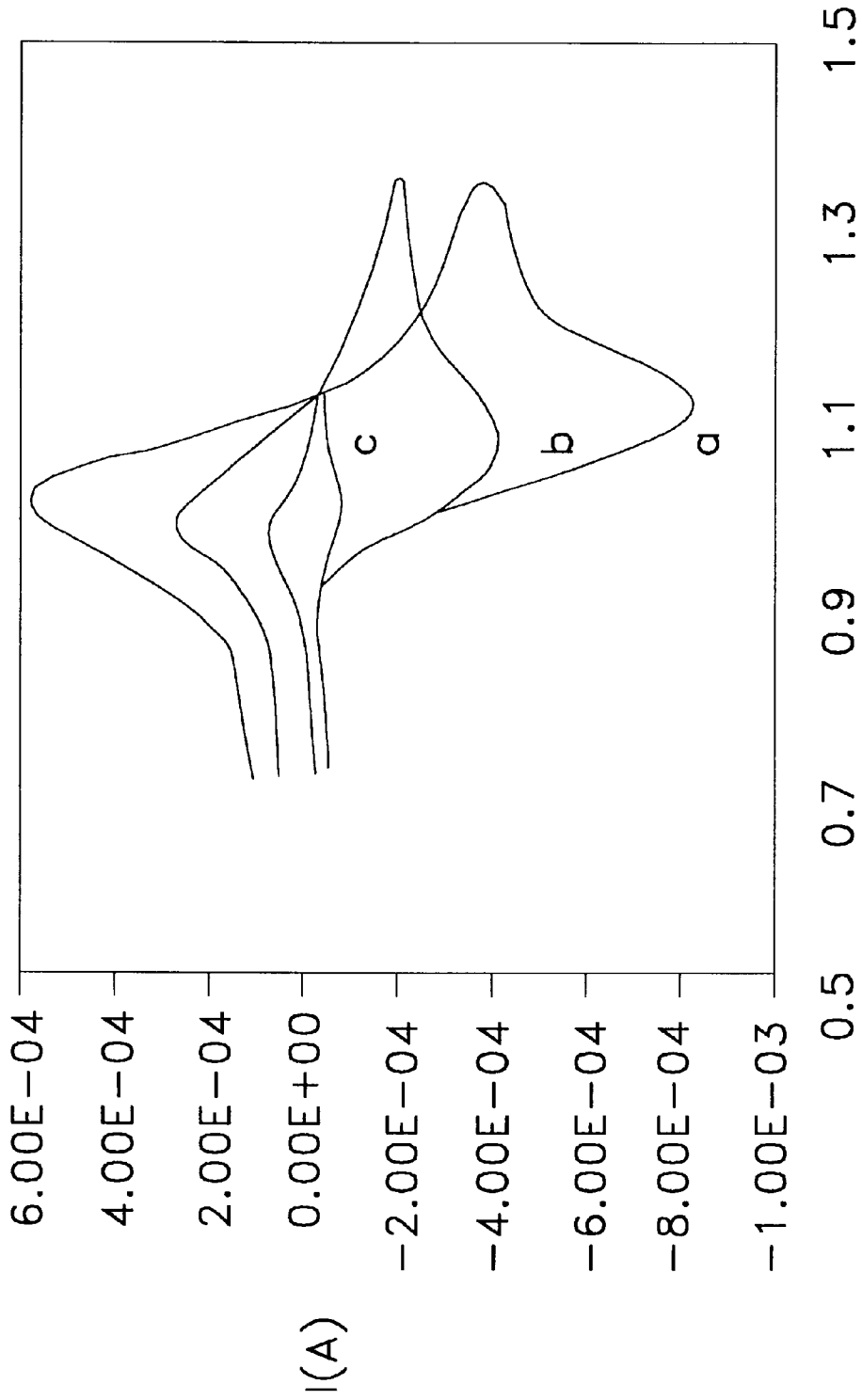

Figure 12A



$E(V) \text{ vs. SCE}$

Figure 12B

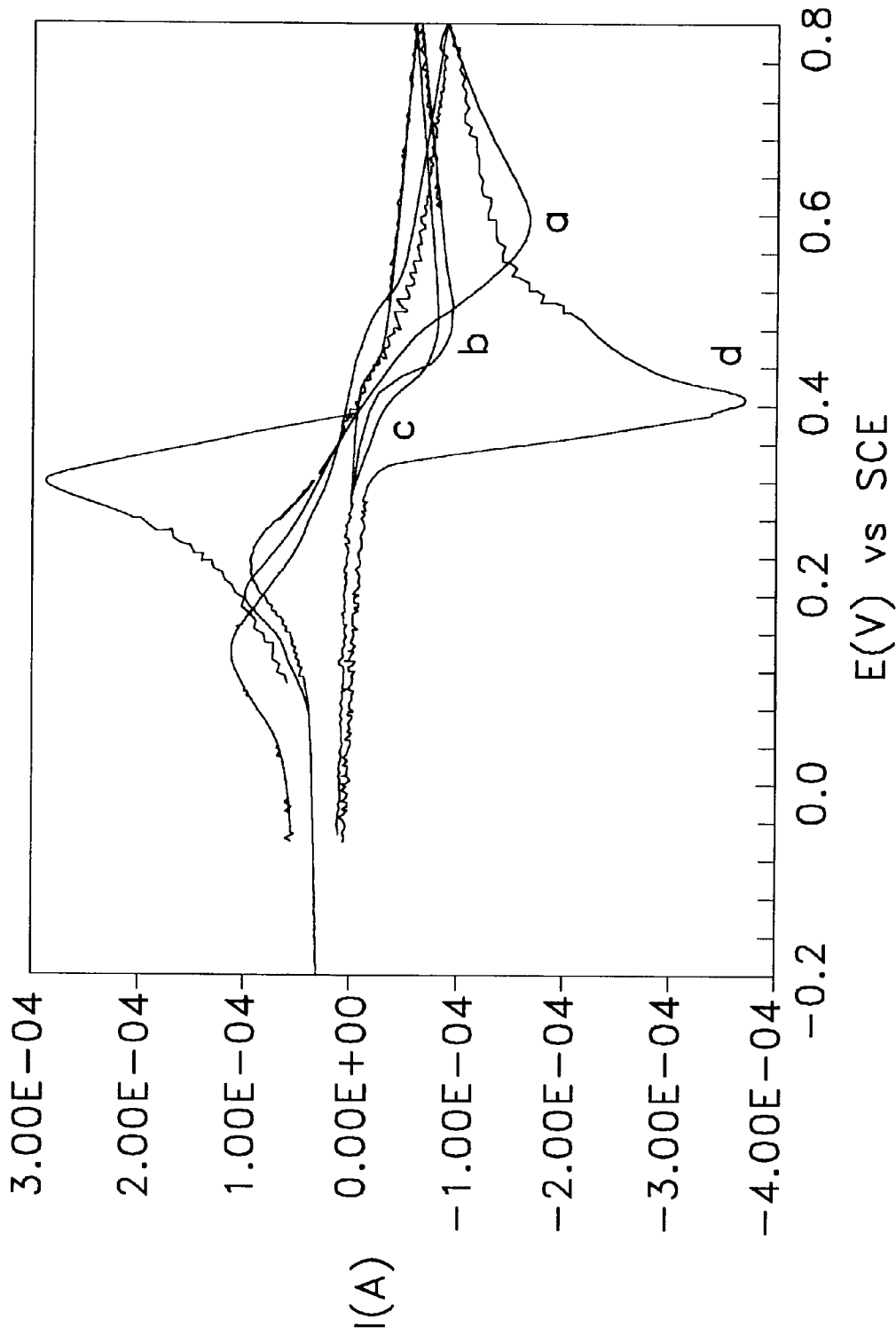

Figure 12C

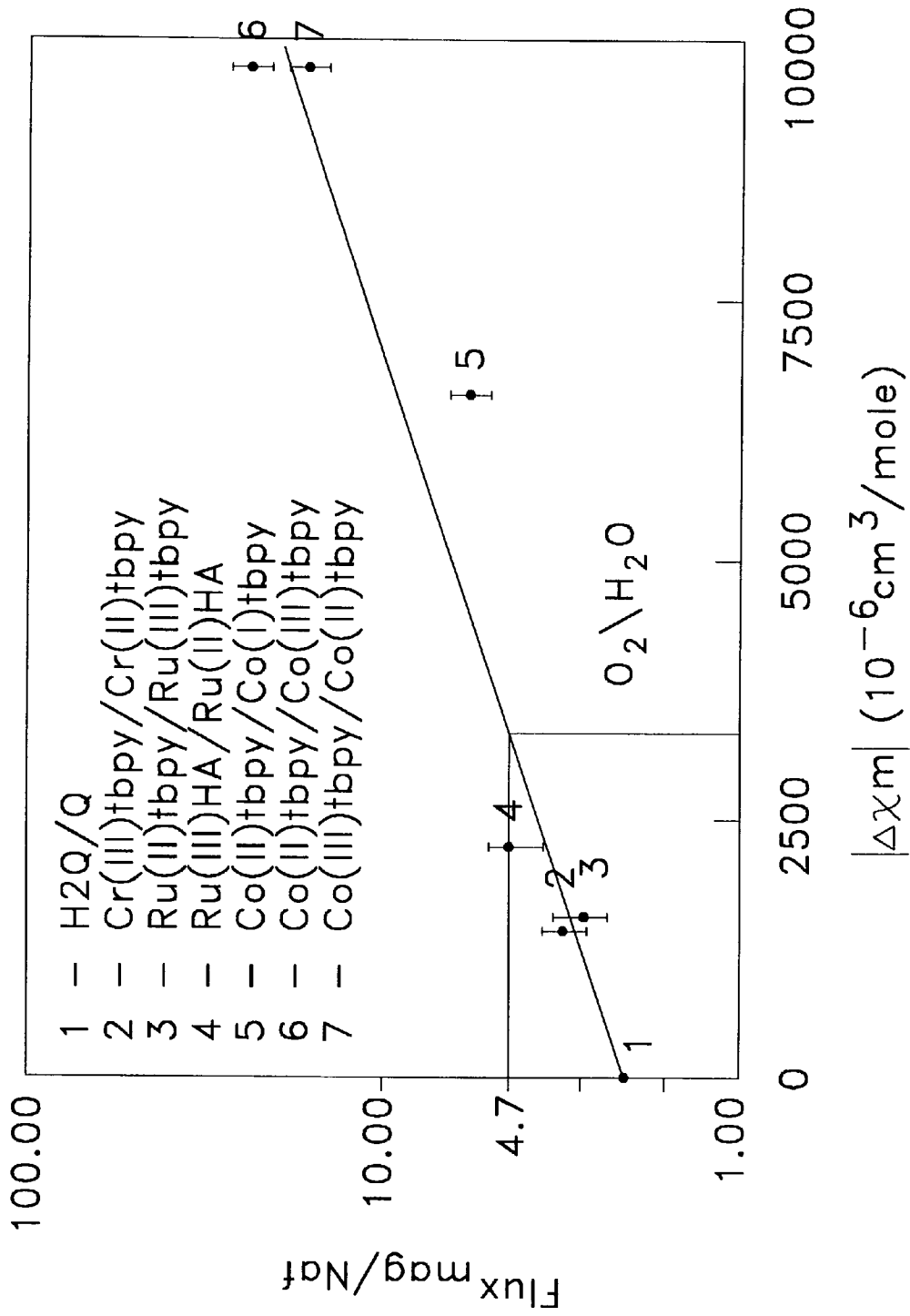

Figure 13

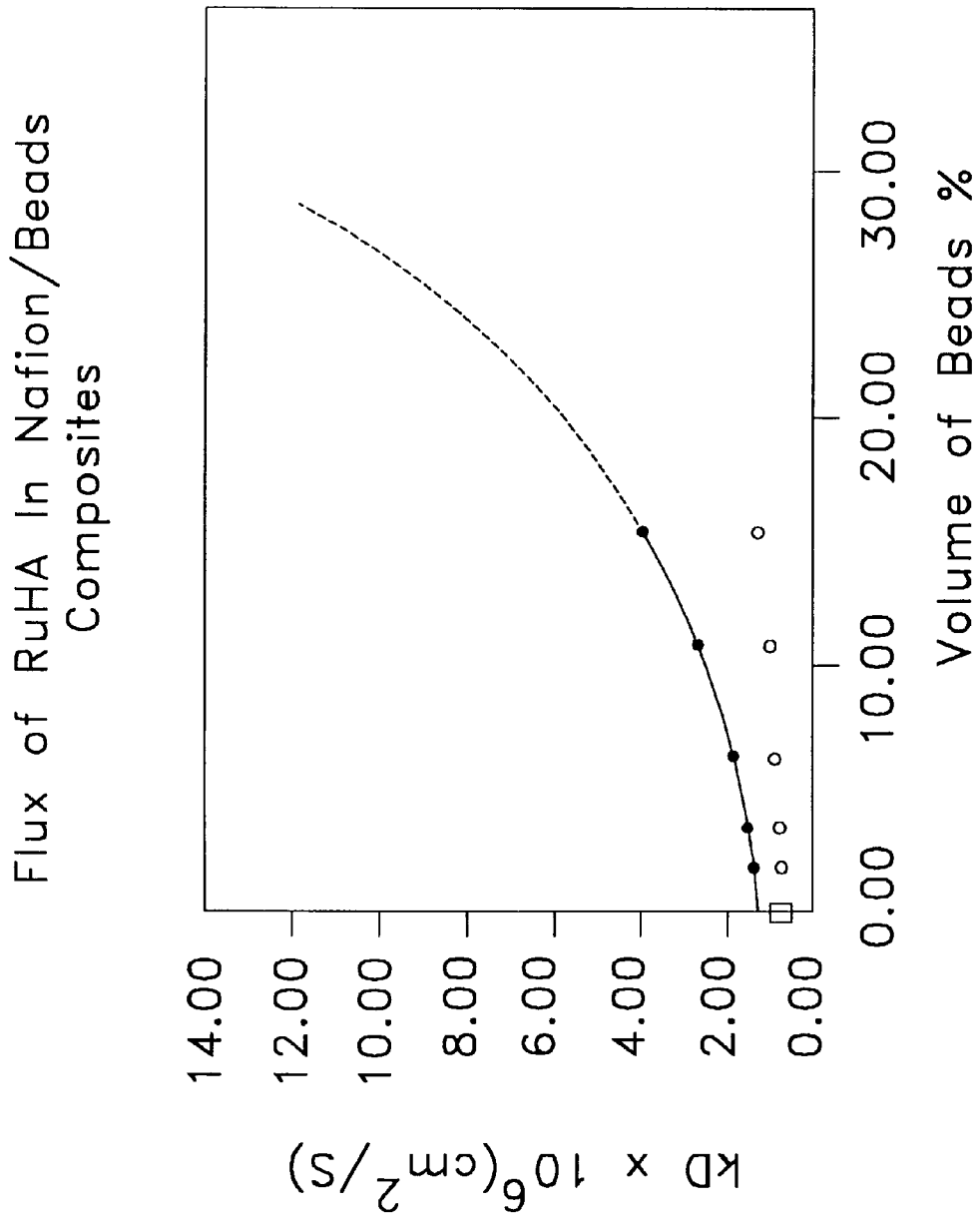
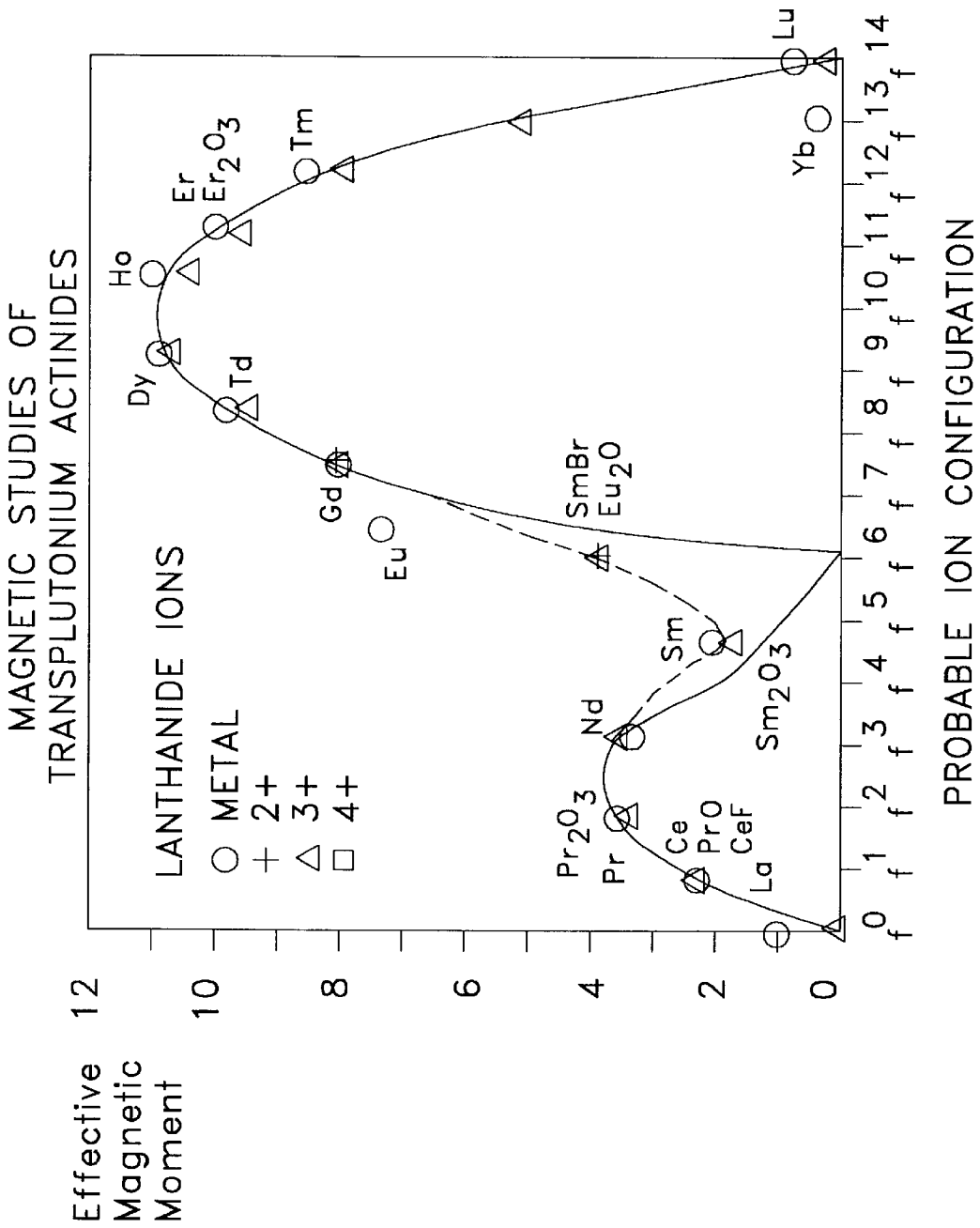

Figure 14



MAGNETIC STUDIES OF
TRANSPUTONIUM ACTINIDES

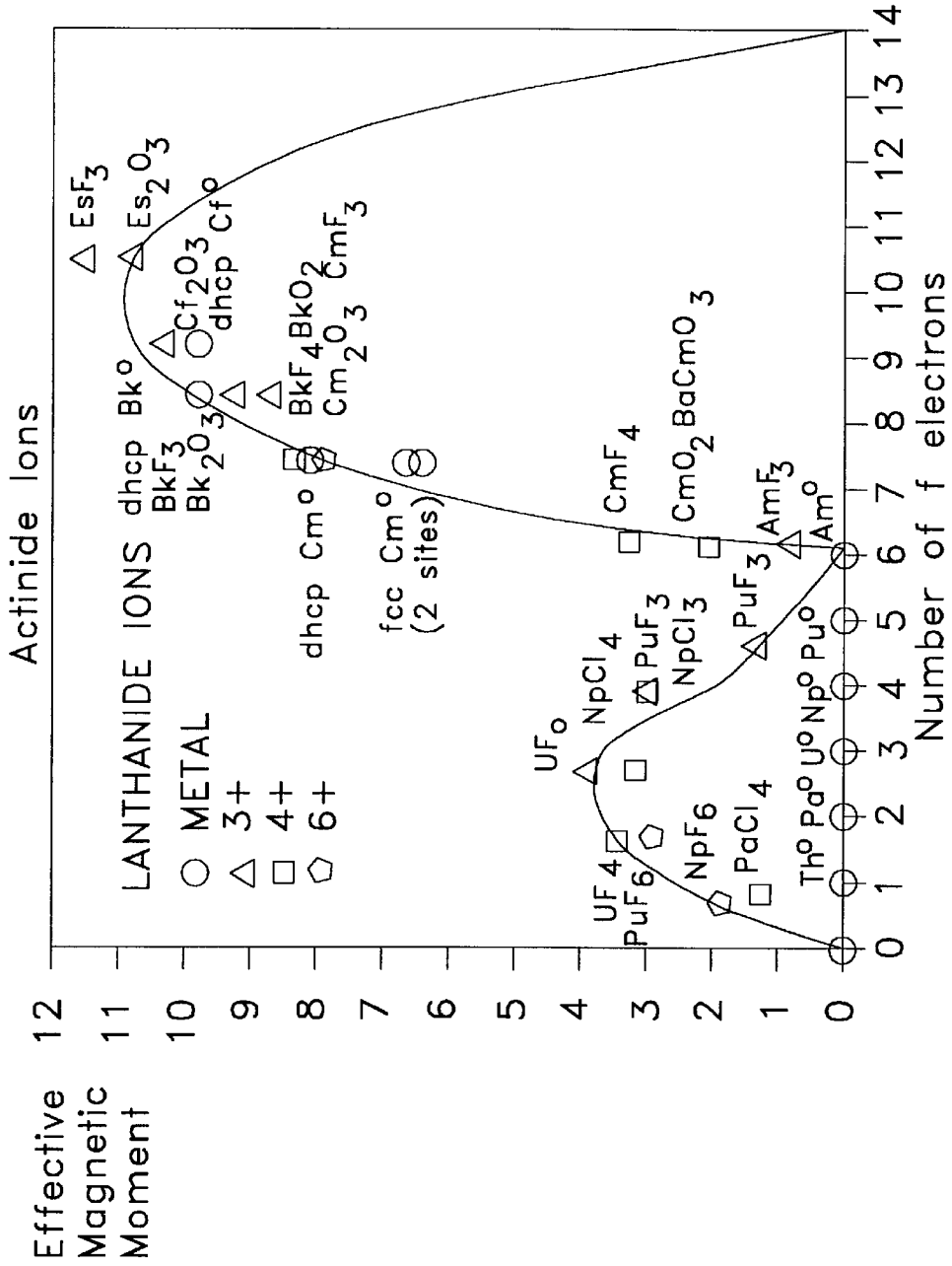
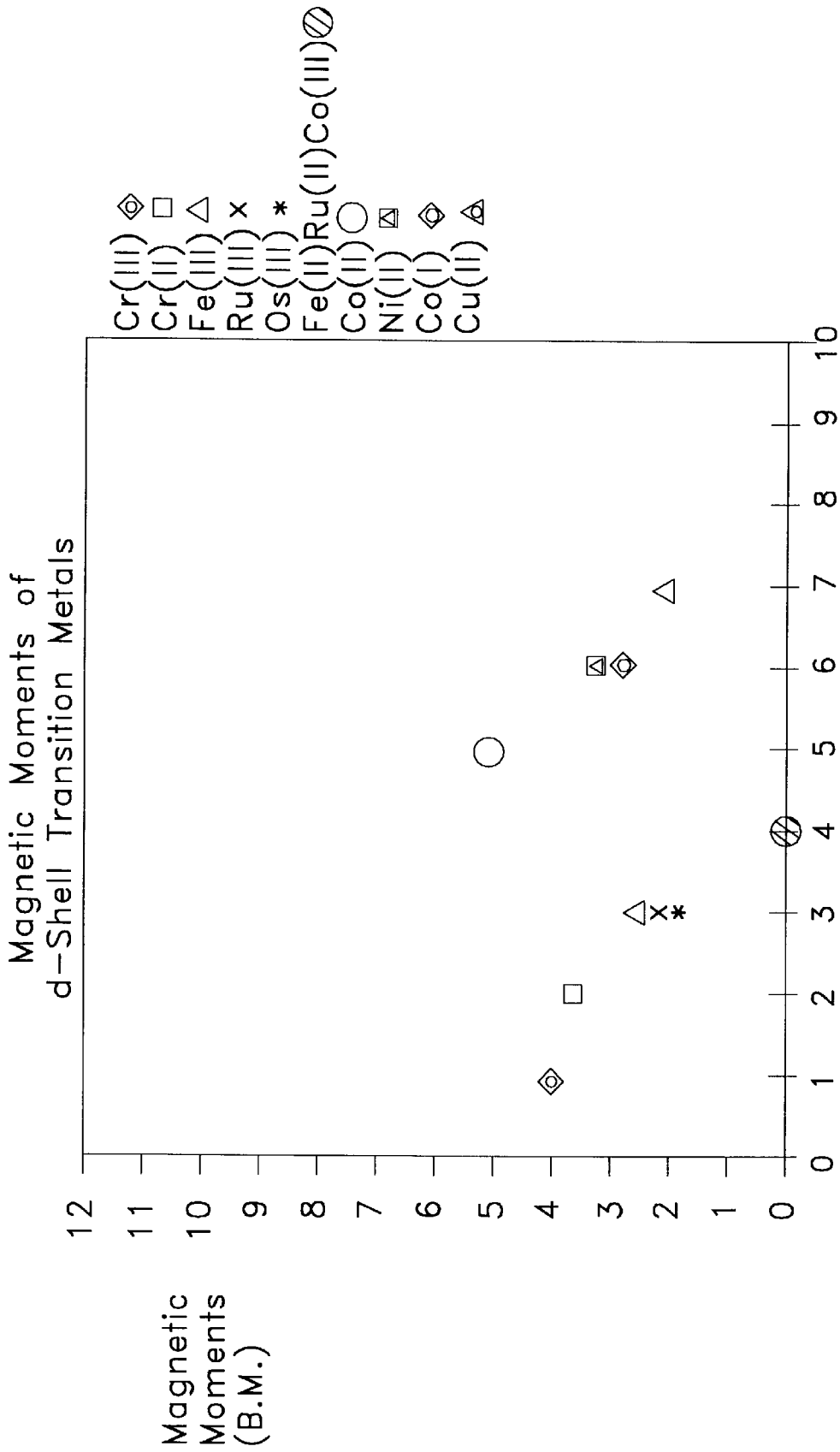

Figure 14B



Number of d electrons
Figure 14C

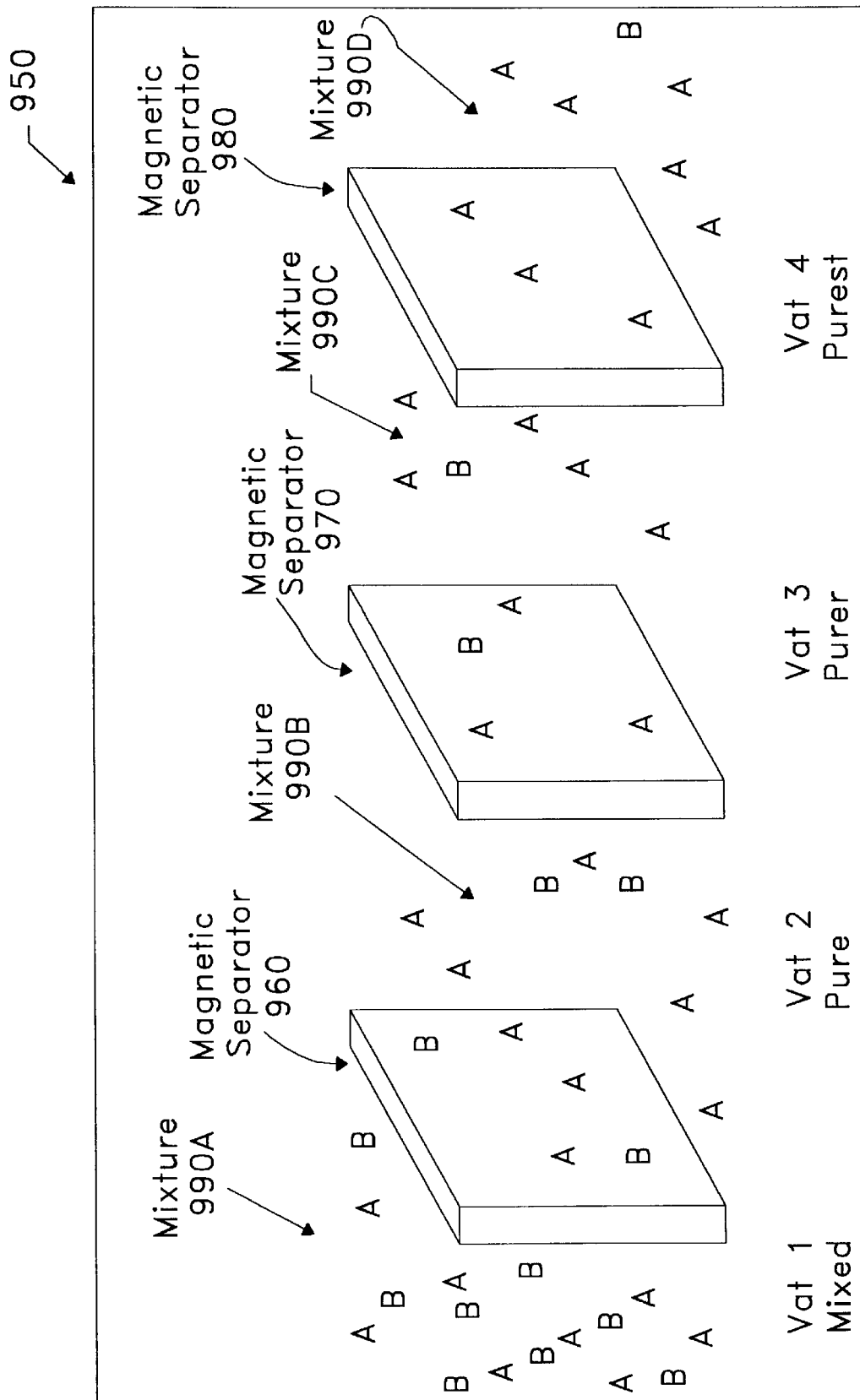

Figure 14D

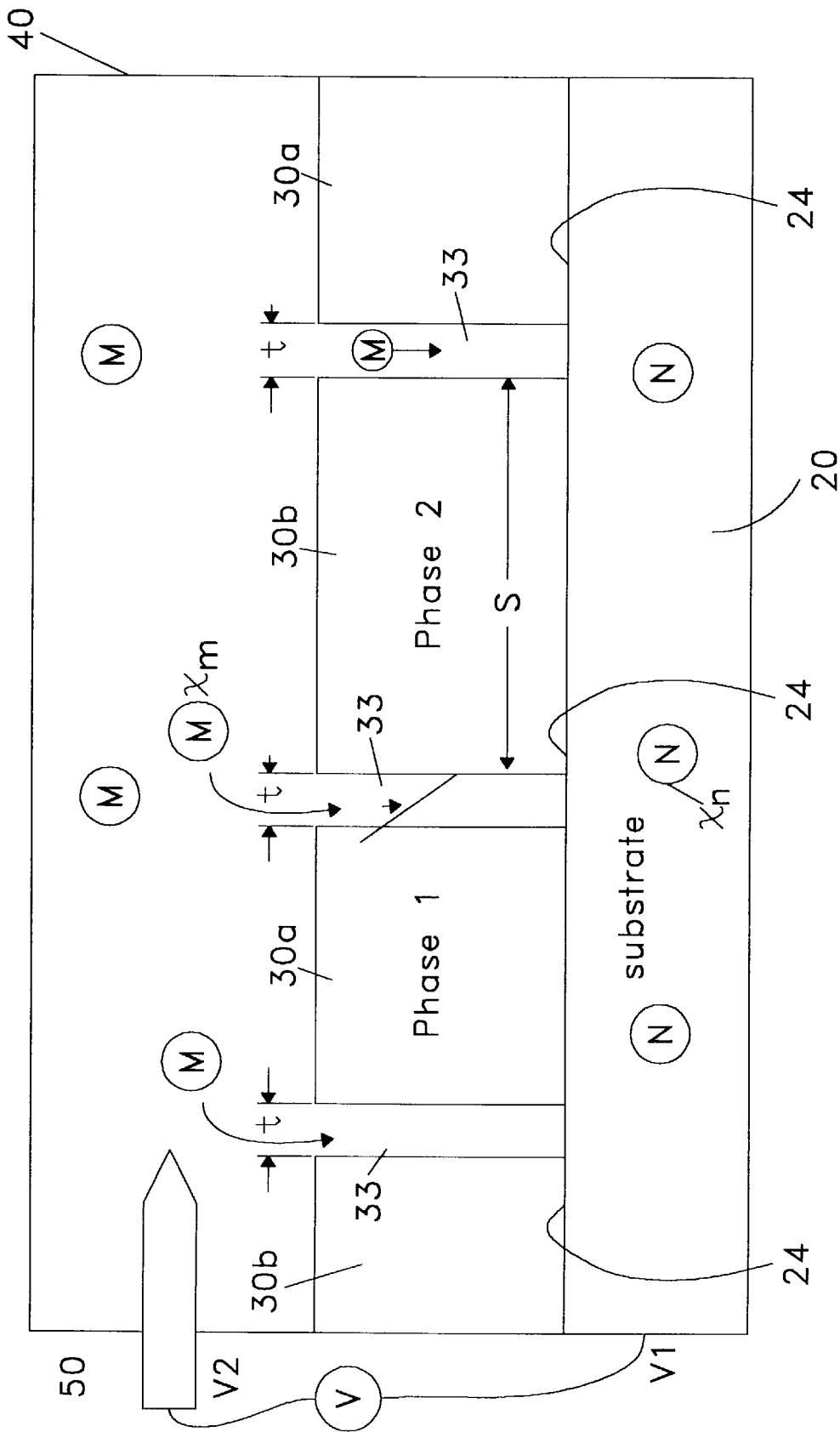

Figure 15A

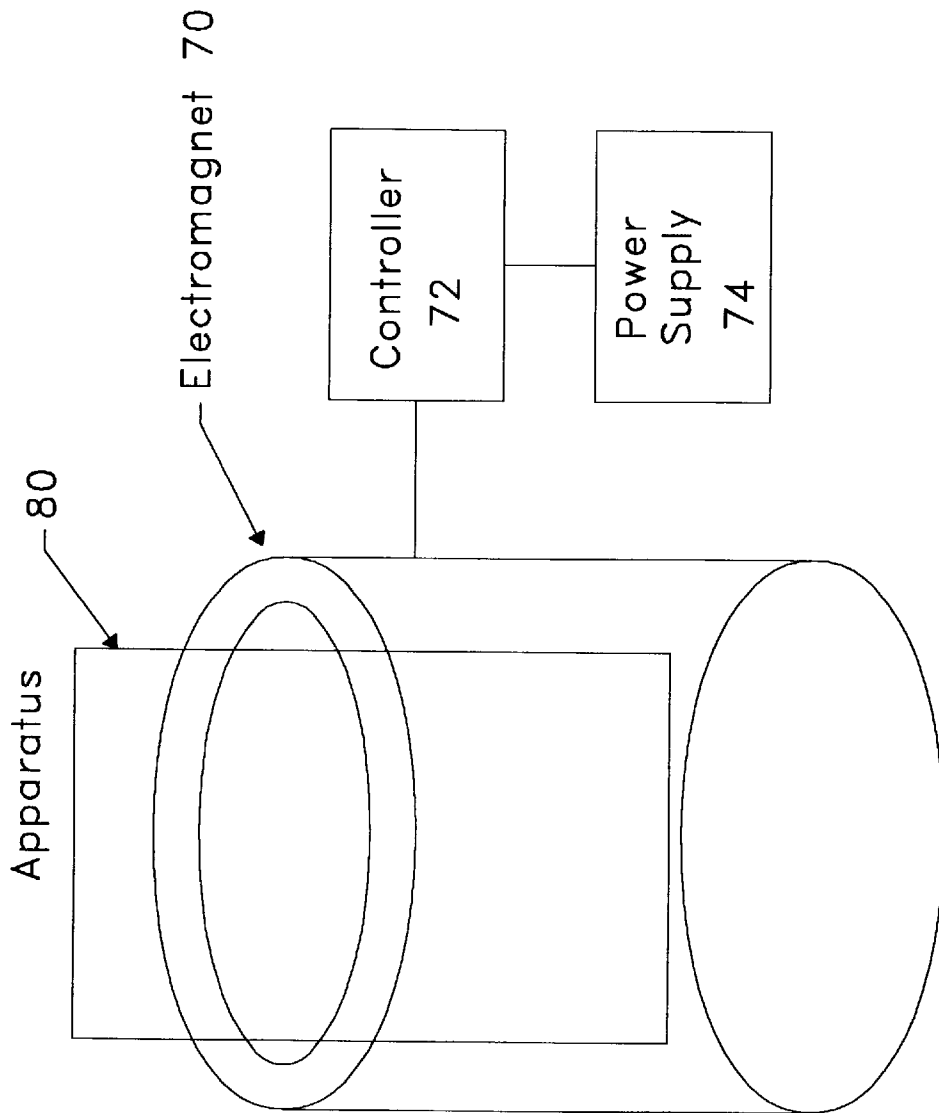

Figure 15B

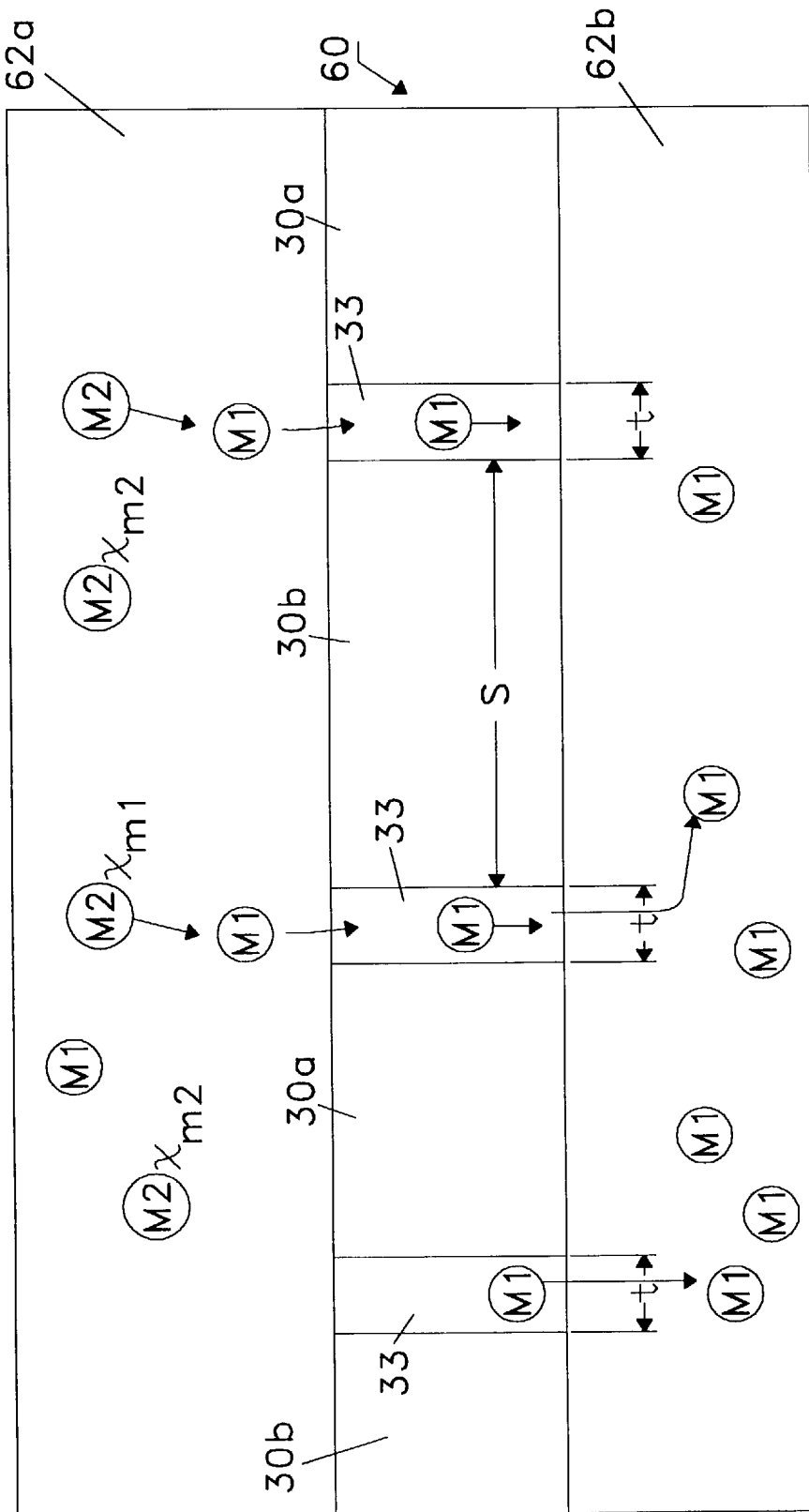

Figure 16

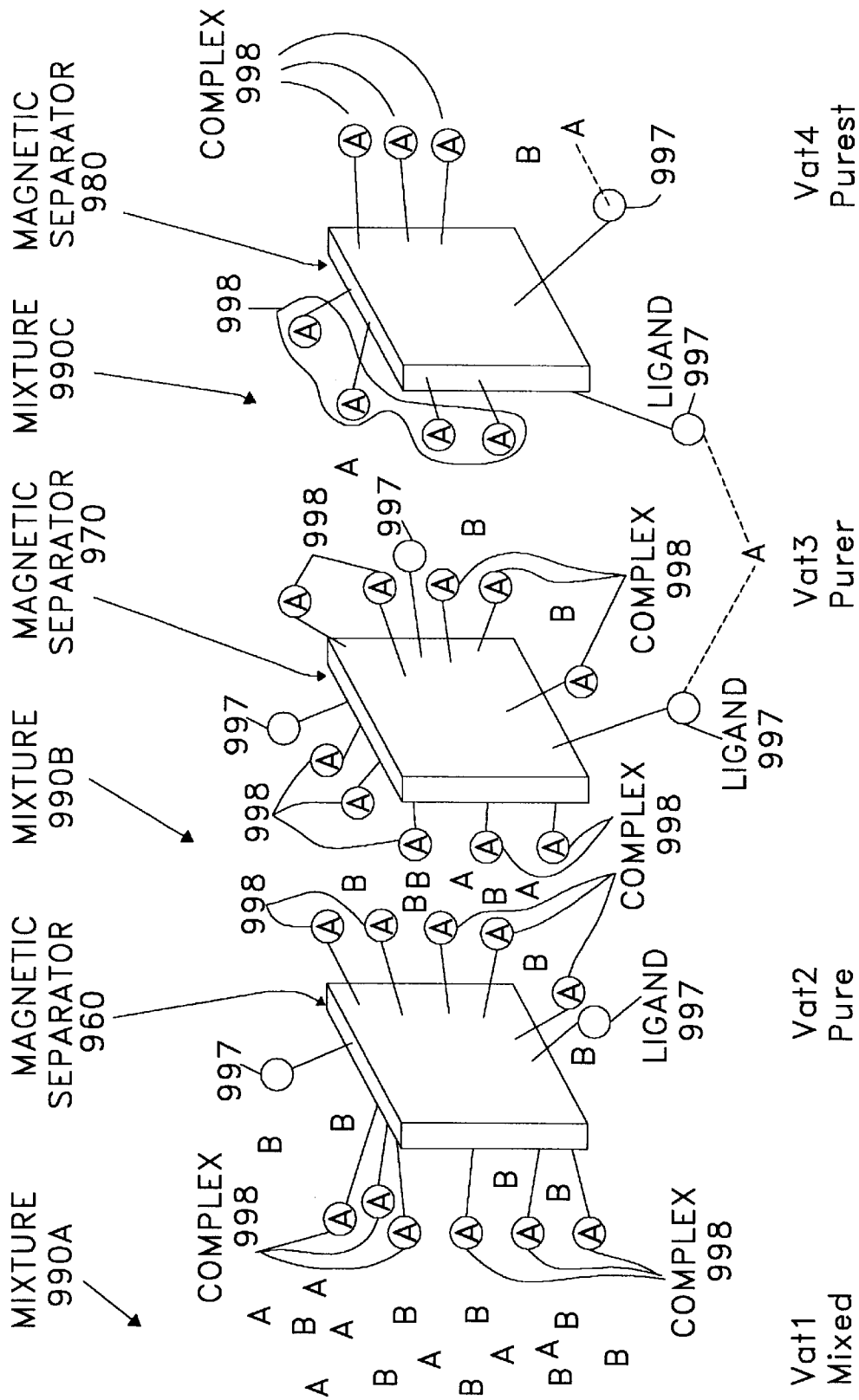

Figure 16B

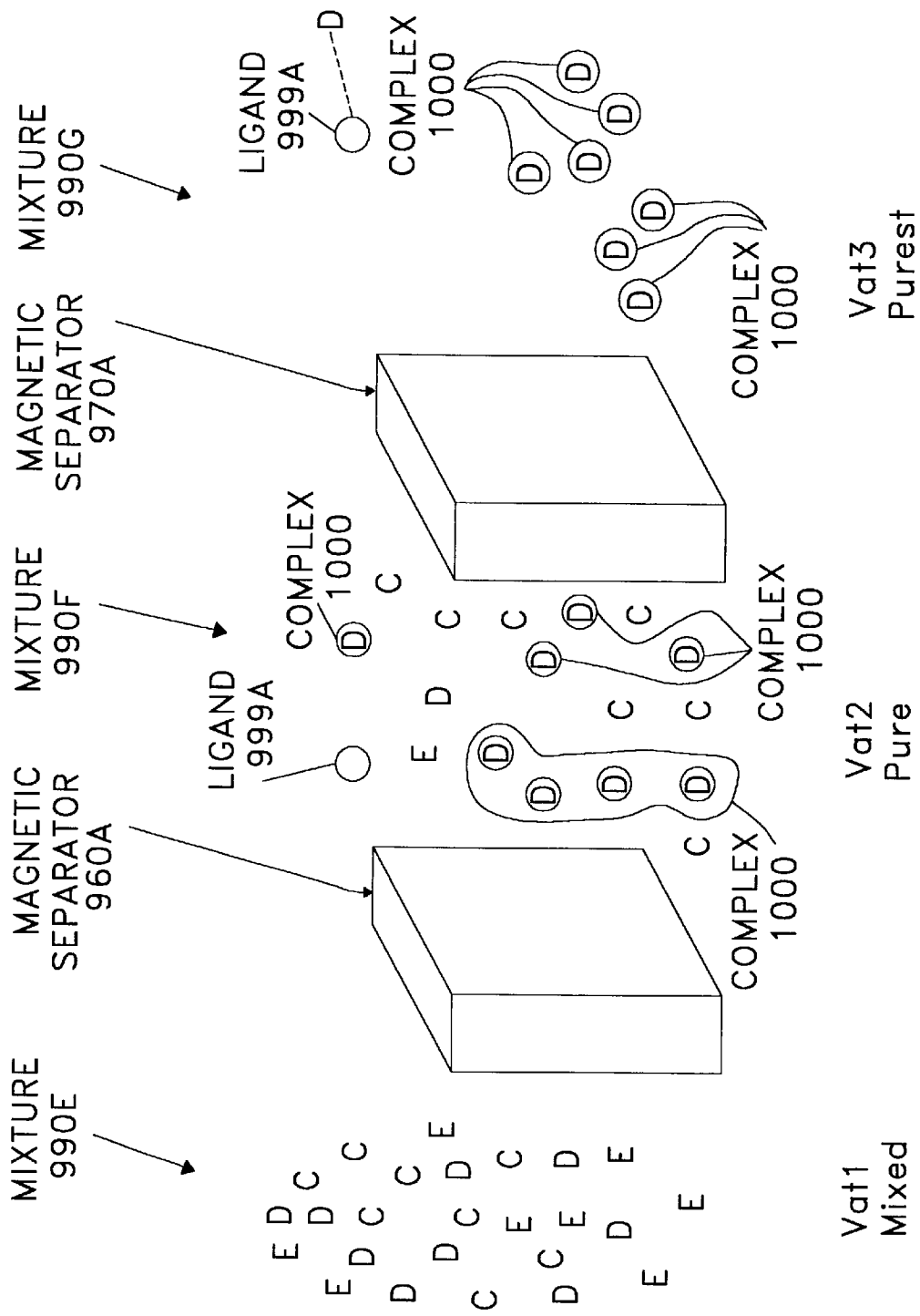

Figure 16C

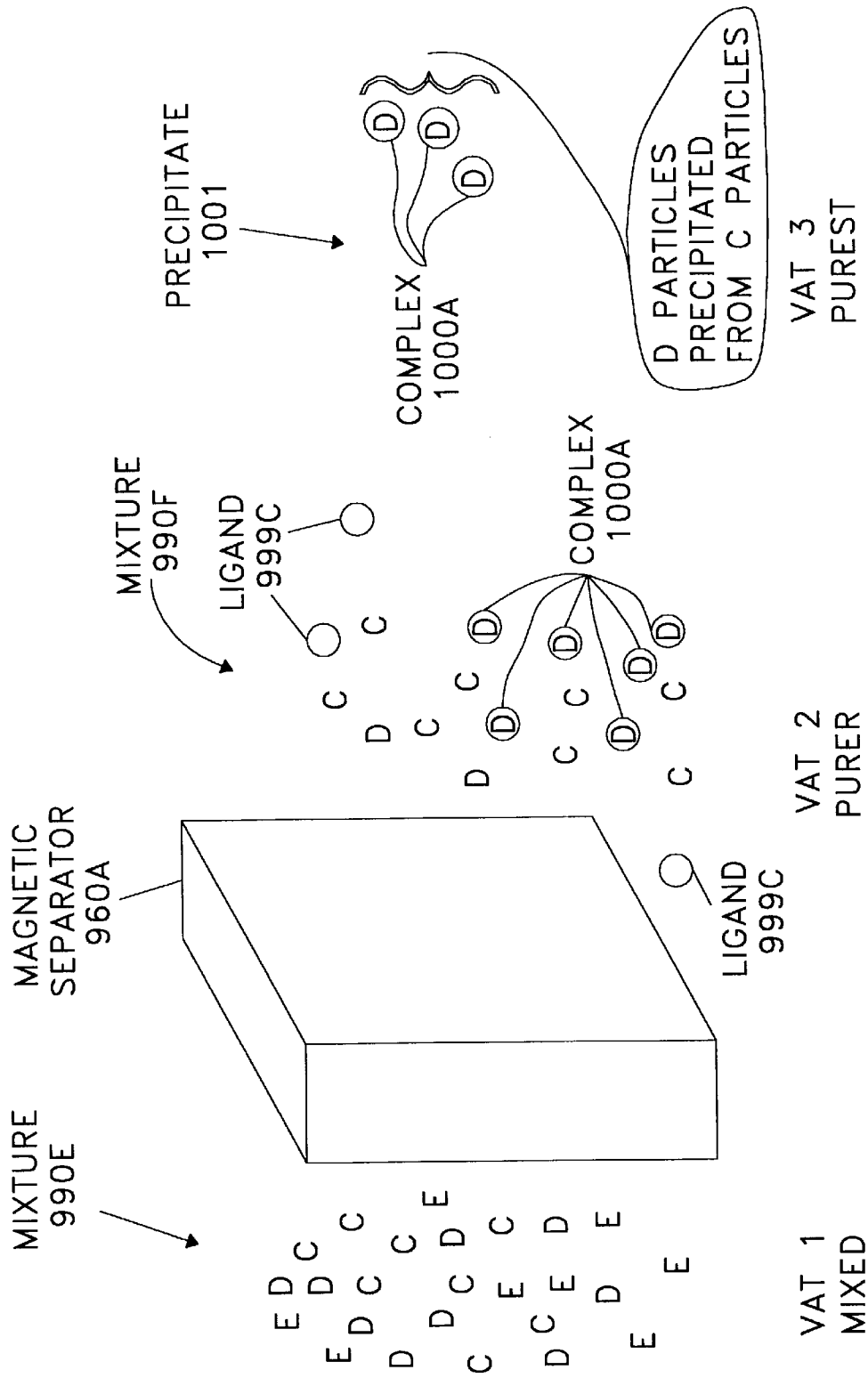

Figure 16D

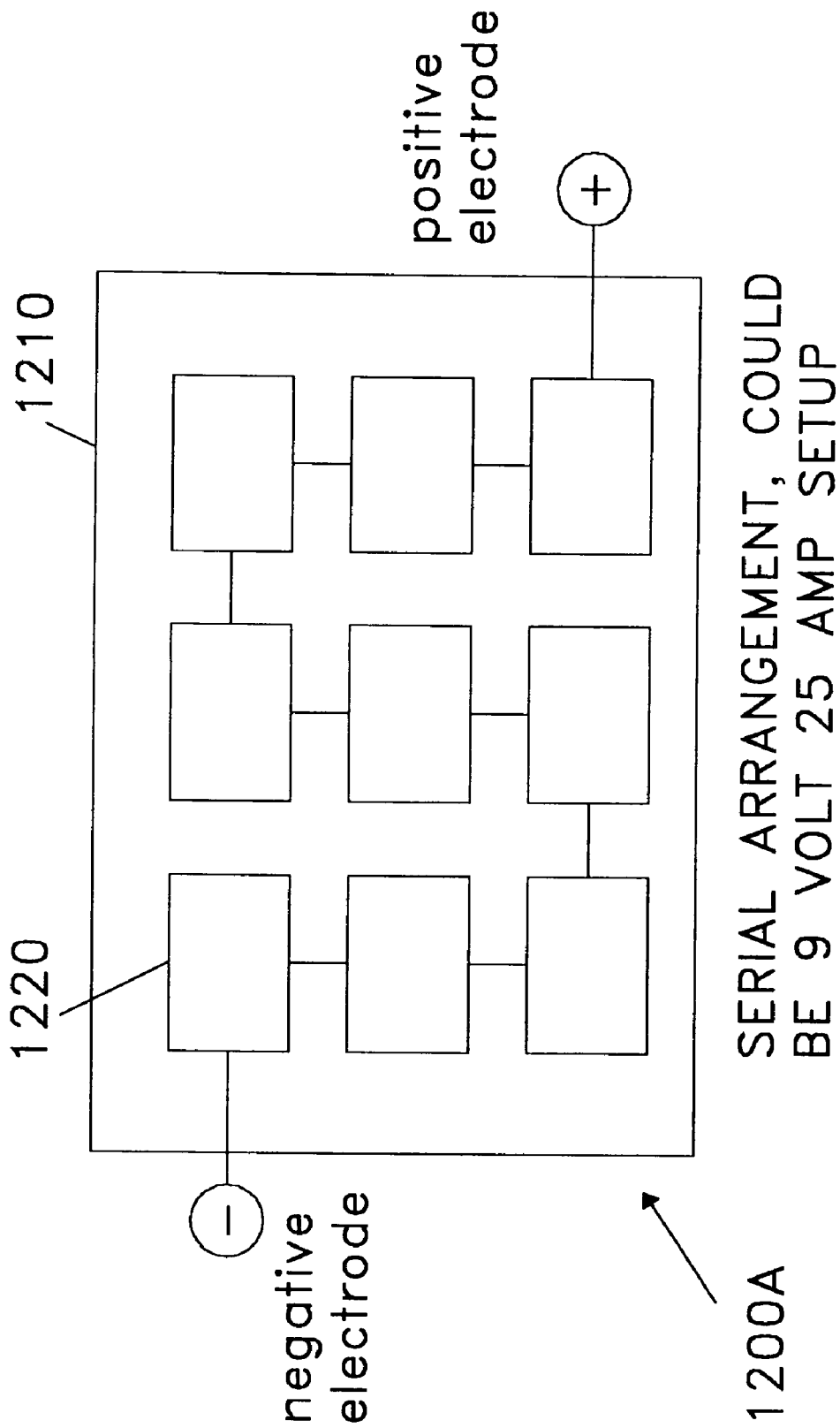
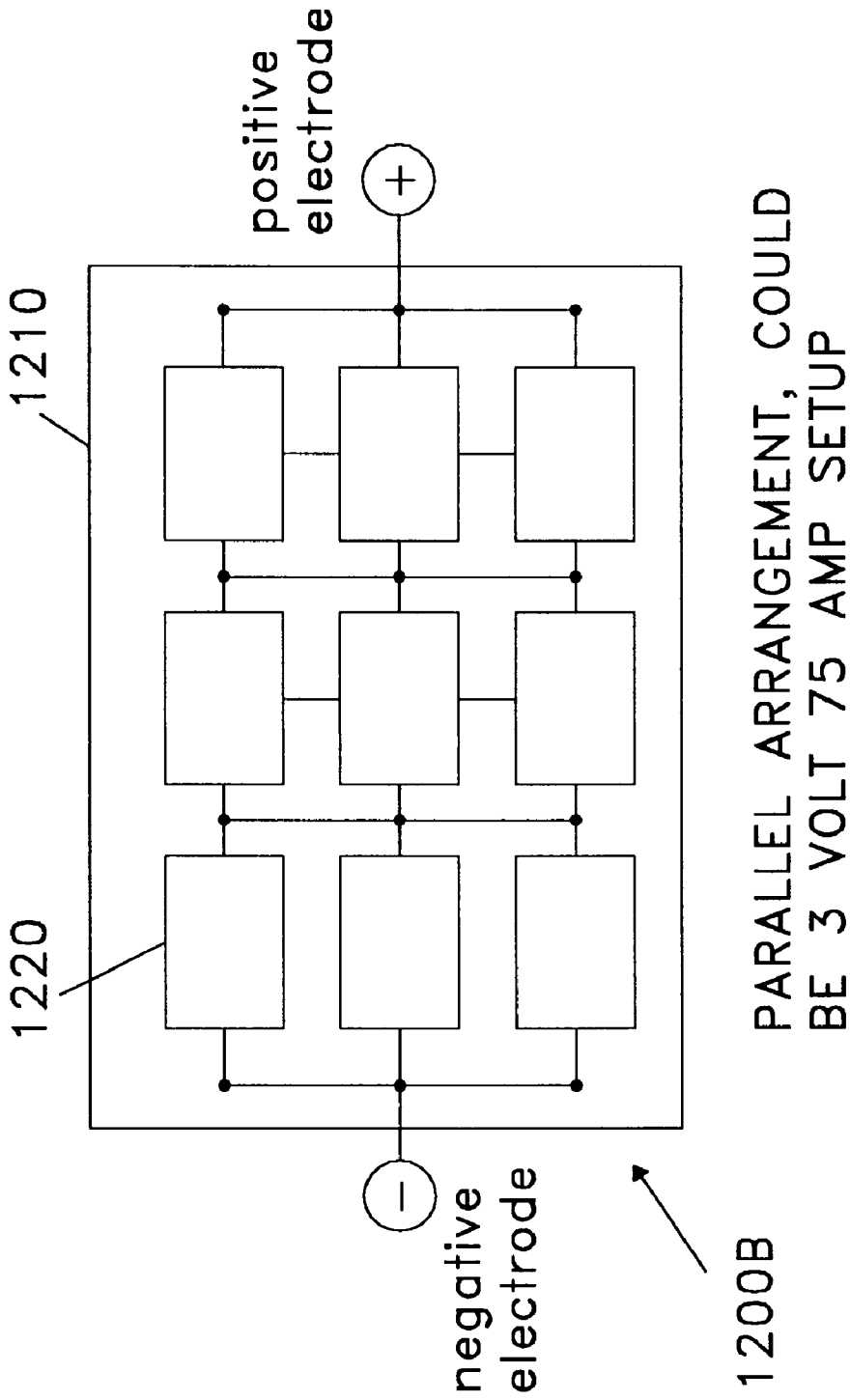

Figure 16E1



PARALLEL ARRANGEMENT, COULD
BE 3 VOLT 75 AMP SETUP

Figure 16E2

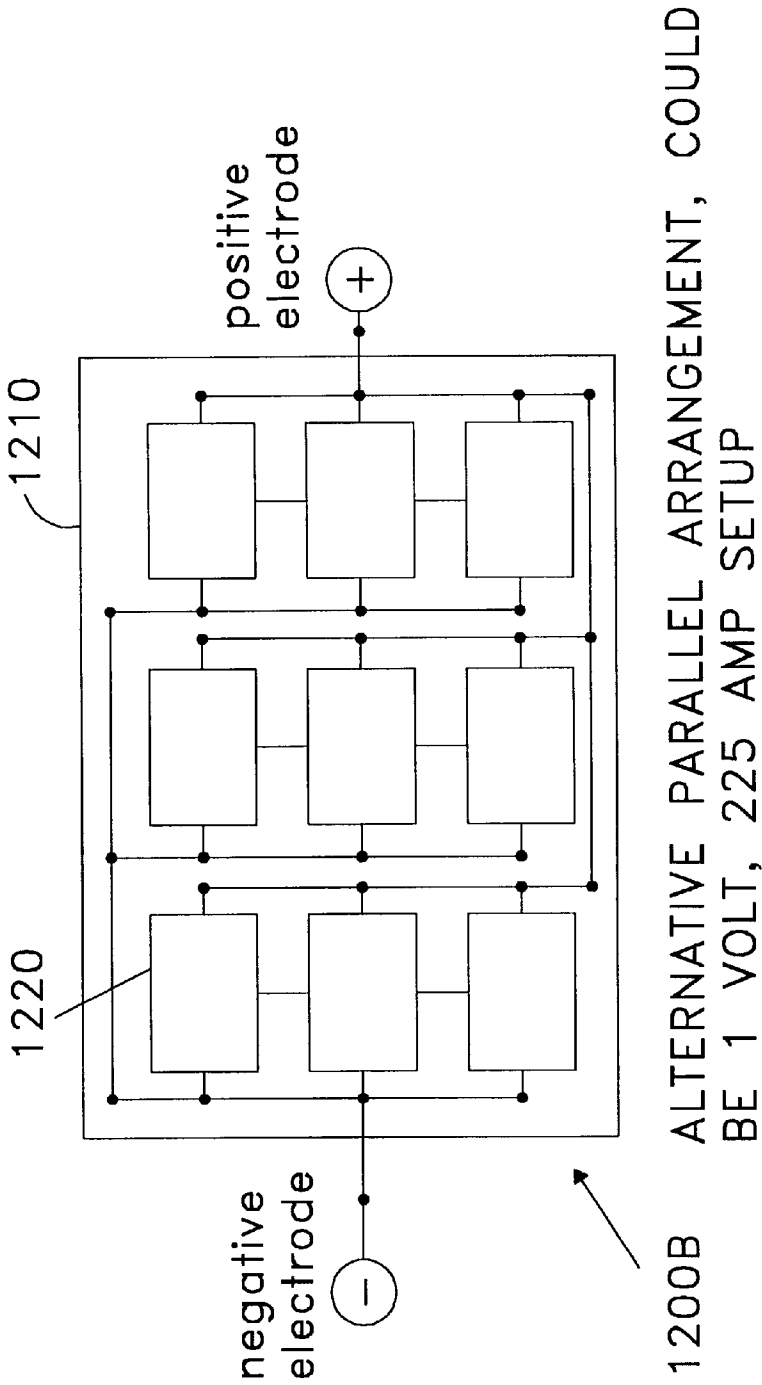

FIG. 16E3

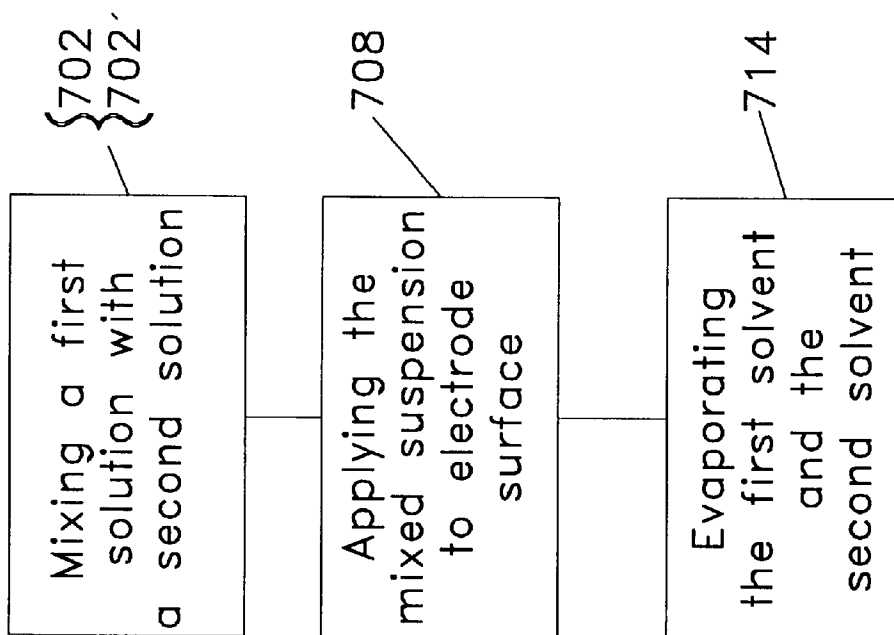

Figure 17

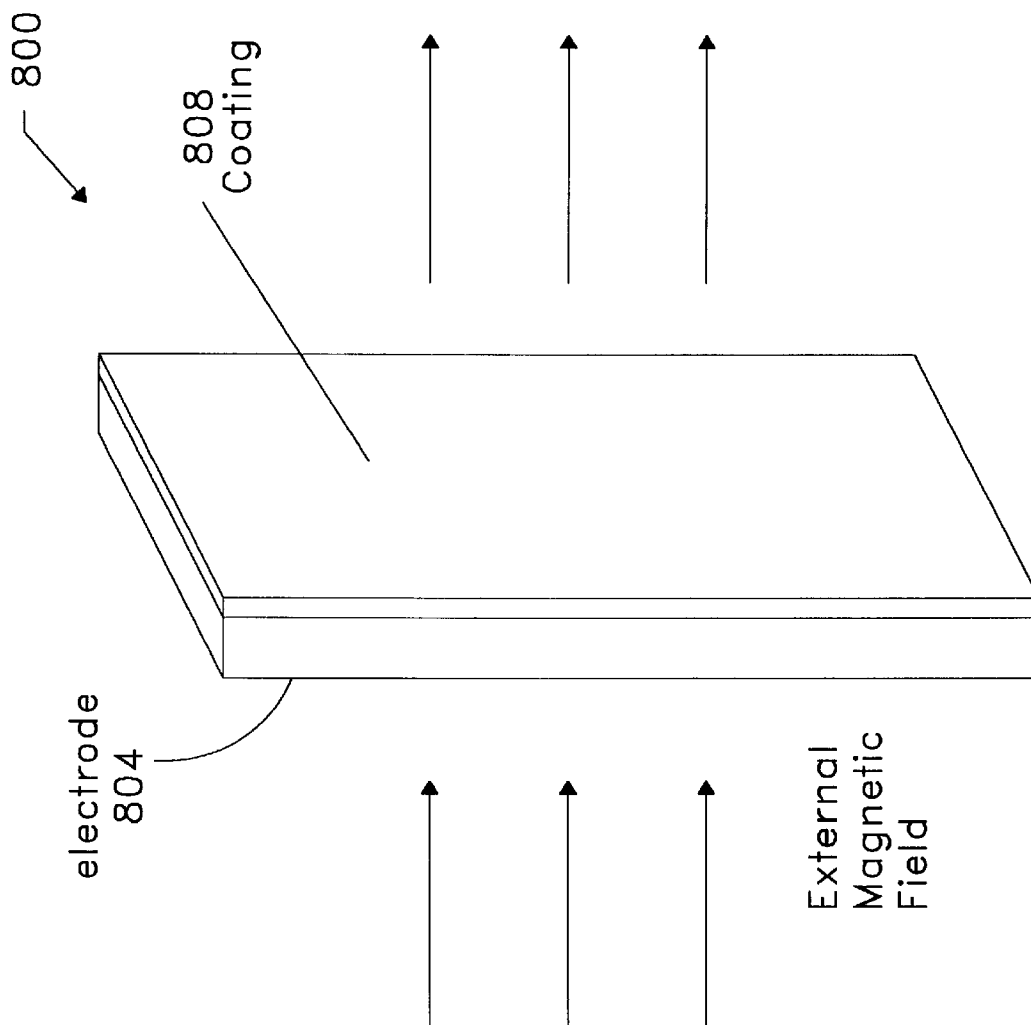

Figure 18A

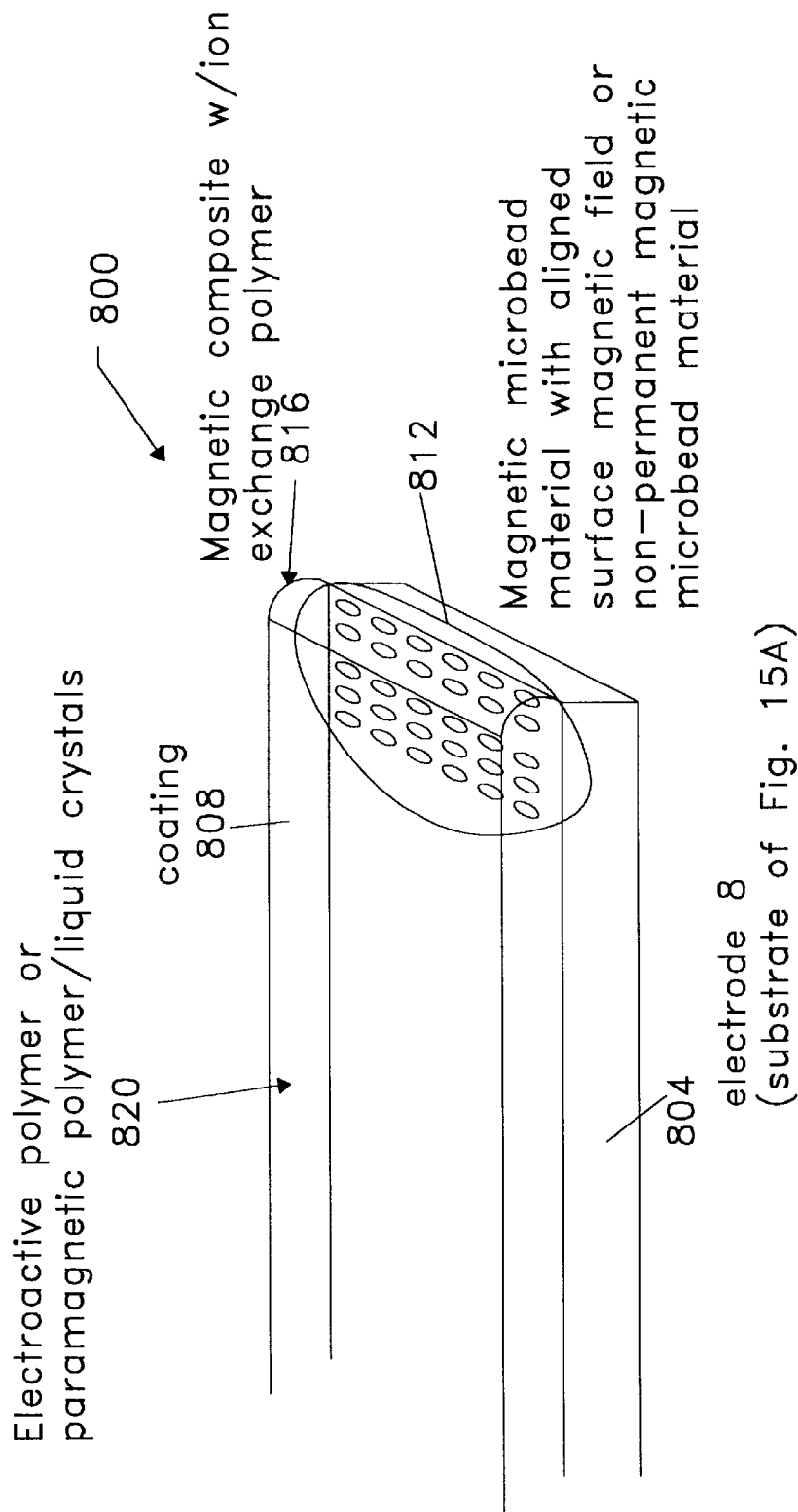

Figure 18B

900

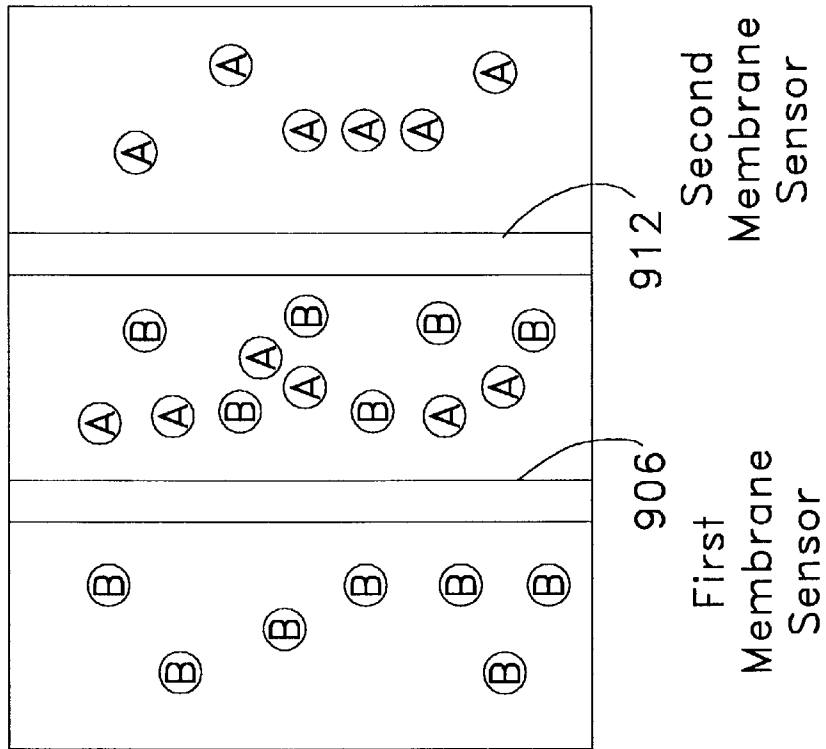

Figure 19

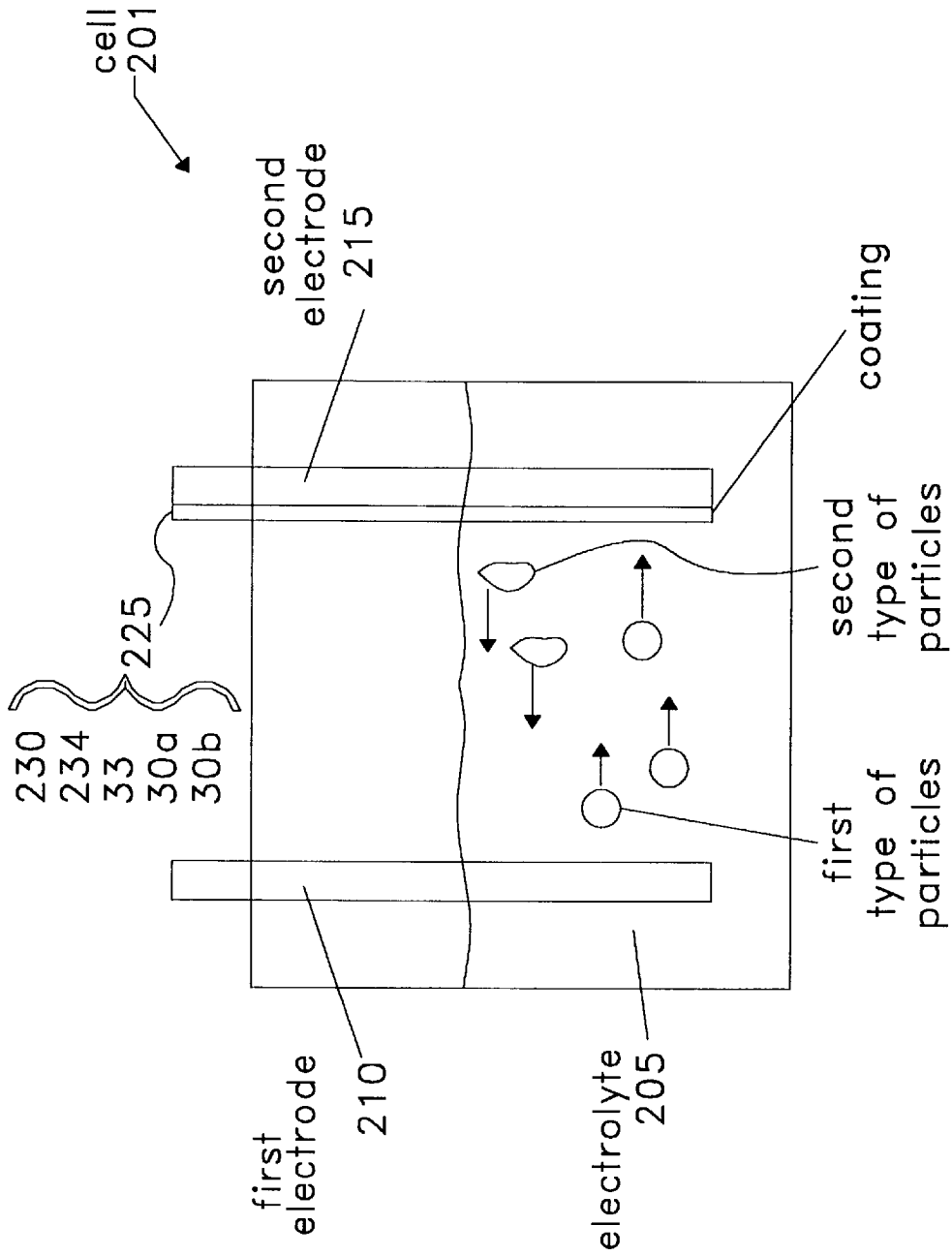

Figure 20

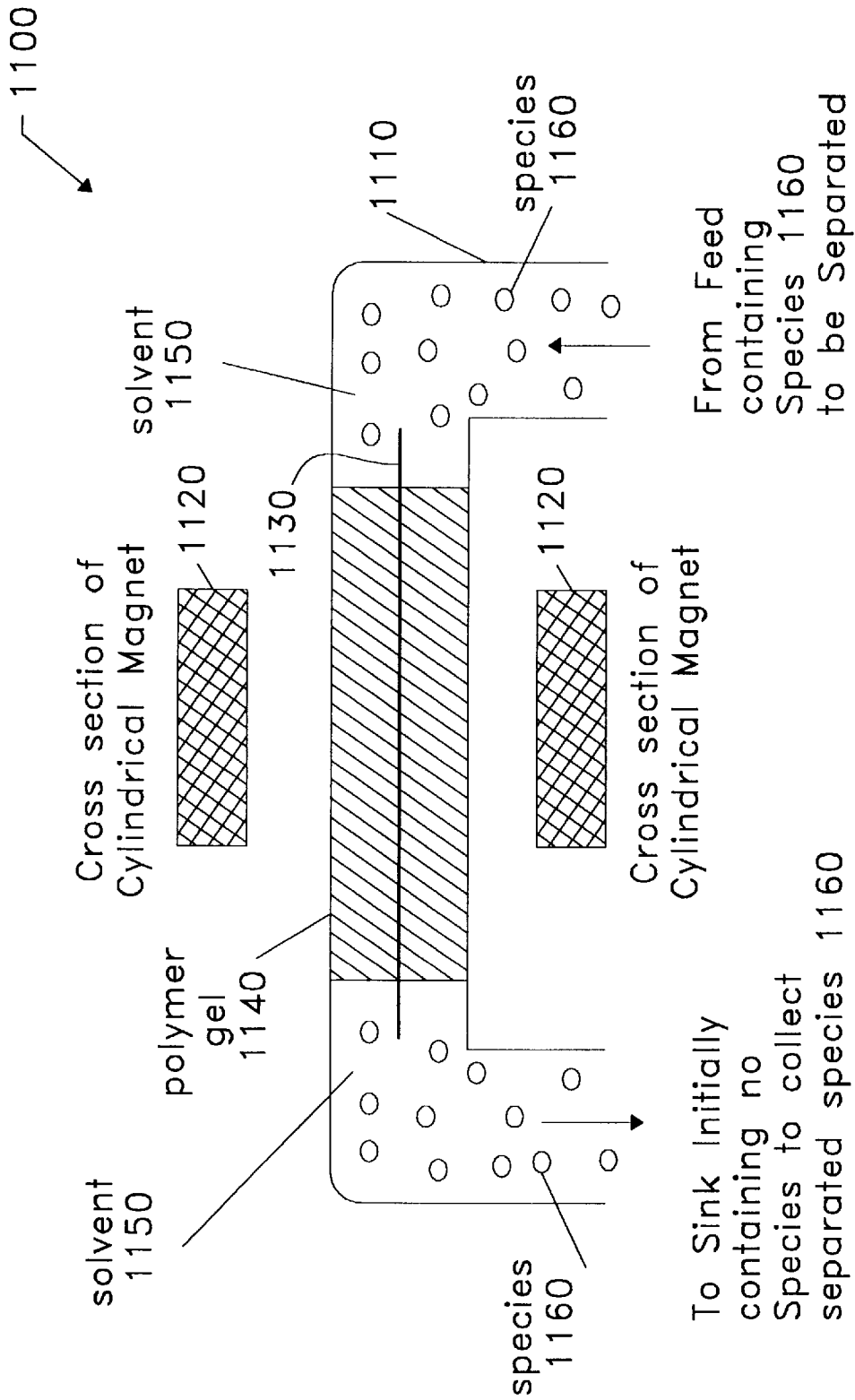

Figure 20A

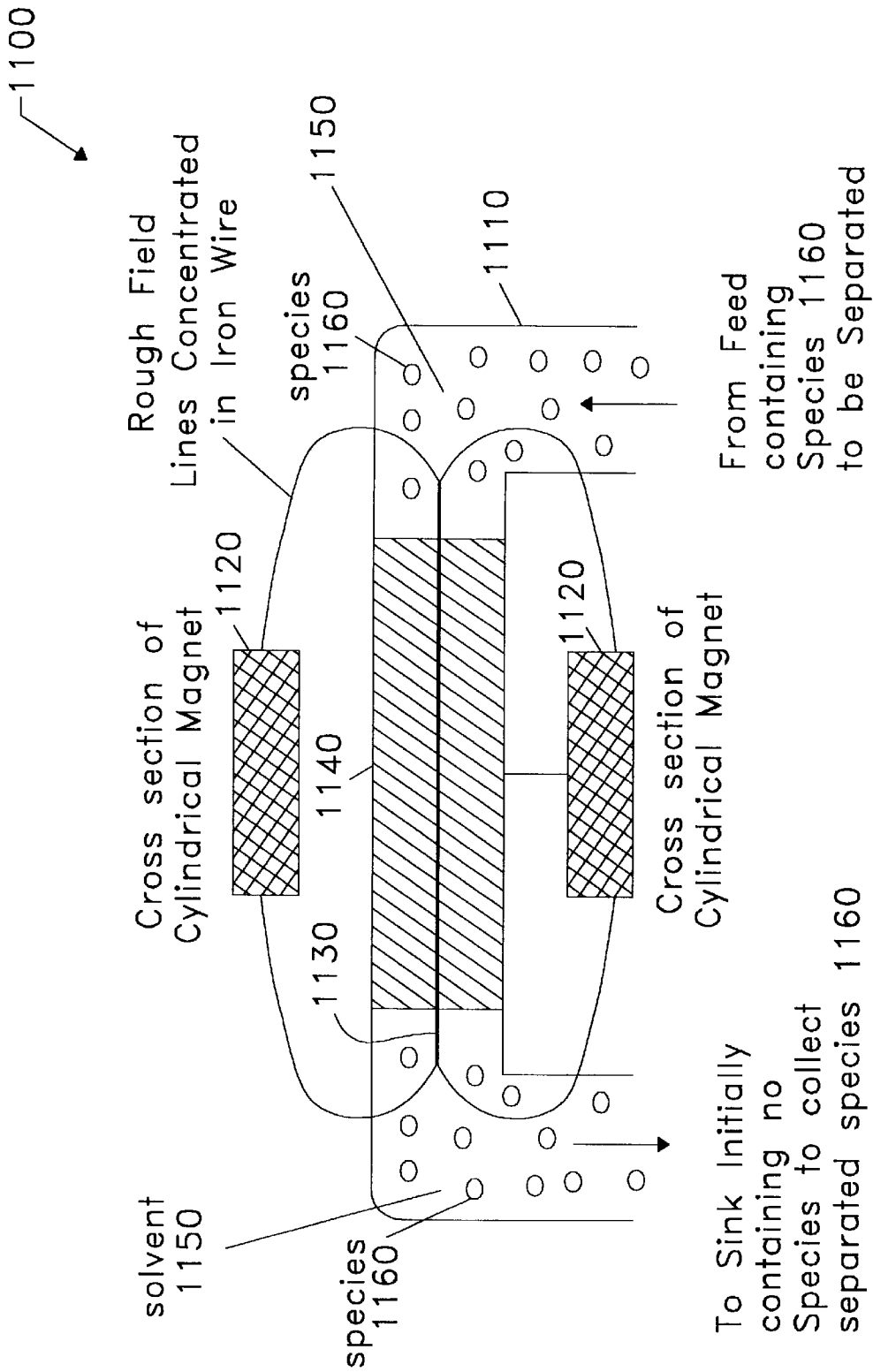

Figure 20B

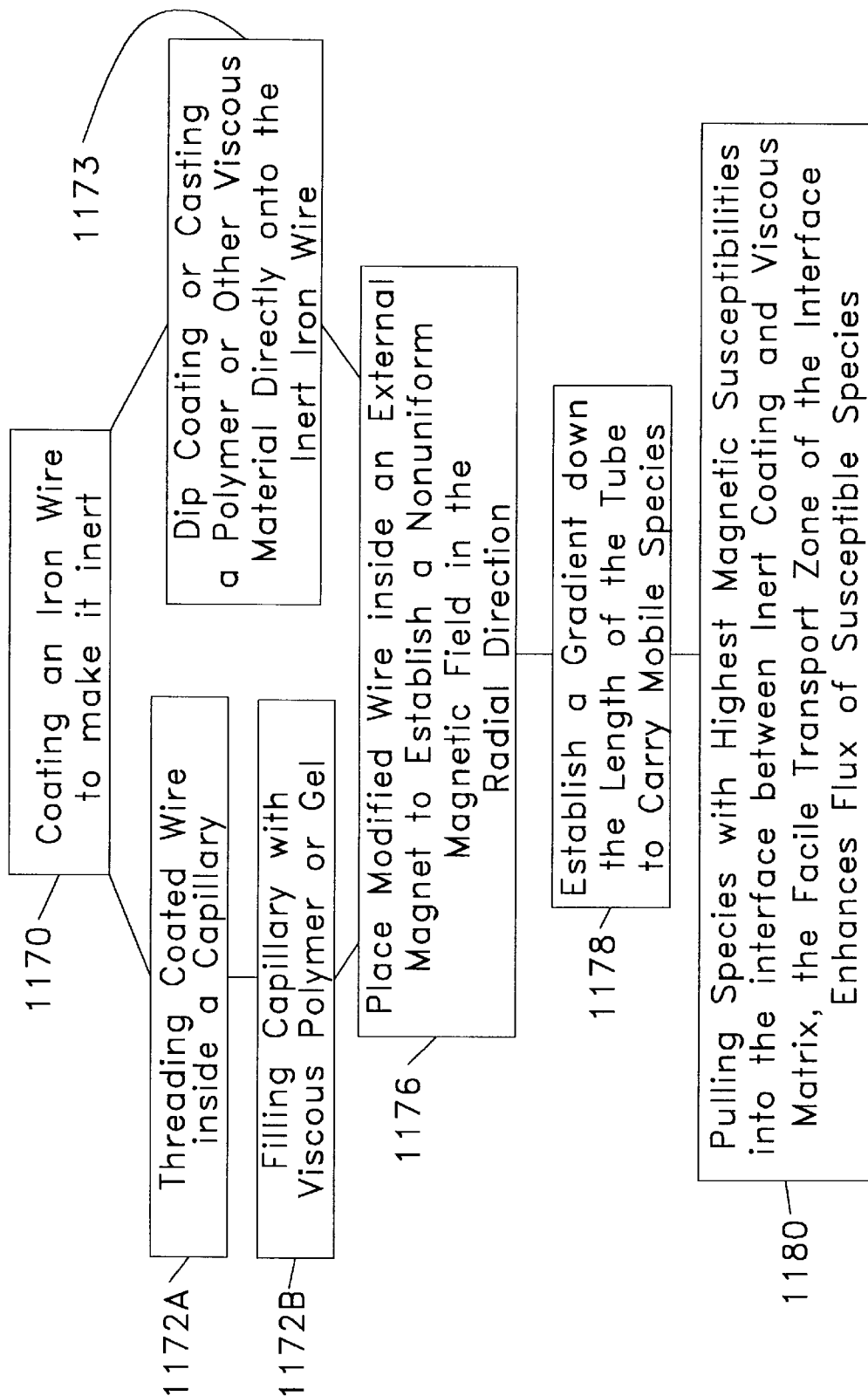

Figure 20C

GRADIENT INTERFACE MAGNETIC COMPOSITES AND SYSTEMS THEREFOR

RELATED APPLICATION

This application is a continuation-in-part of U.S. application Ser. No. 08/294,797 filed Aug. 25, 1994 which is abandoned.

Part of the work performed during the development of this invention utilized U.S. government funds under grants No. CHE92-96013 and No. CHE93-20611 from the National Science Foundation, Chemistry Division, Analytical and Surface Science. The government may have certain rights in this invention.

BACKGROUND OF THE INVENTION

1. Field of the Invention

This invention relates generally to a method for forming and exploiting gradients at the interfaces between components of a composite material as well as the composite material itself and devices which incorporate the material. In particular, the invention relates to a method for forming and exploiting magnetic gradients at the interfaces between components of a composite magnetic material and the magnetic composite material itself as well as devices which incorporate the composite material such as electrochemical systems and separators including fuel cells, batteries, membrane sensors, flux switches, chromatographic separations, and nonelectrochemical separations resulting in enhanced and modified flux and performance in those systems. The invention also relates to apparatus, methods of making, and methods of using composite magnetic materials and interface gradients for the separation of transition metals, both light and heavy, from other species and from each other.

2. Background of the Related Art

In the detailed description of preferred embodiments, it will be shown that interfacial gradients in properly prepared composite materials can be exploited to enhance flux in many types of electrochemical systems such as fuel cells, batteries, membrane sensors, filters and flux switches. Such interfacial gradients may also be exploited in separators involving chromatographic separations and nonelectrochemical separations including, but not limited to, separations of light and heavy transition metals and transition metal complexes. The heavy transition metals include the lanthanides and the actinides which have atomic numbers 59-71 and 90-103, respectively. First, however, the following discussion provides a brief overview of the current understanding of magnetic properties in composites. In particular, the discussion below summarizes the thermodynamic, kinetic and mass transport properties of bulk magnetic materials. These bulk properties and molecules in magnetic fields are fairly well understood.

Rudimentary Magnetic Concepts

Paramagnetic molecules have unpaired electrons and are attracted into a magnetic field; diamagnetic species, with all electrons paired, are slightly repelled by the field. Radicals and oxygen are paramagnetic; most organic molecules are diamagnetic; and most metal ions and transition metal complexes are either para- or diamagnetic. How strongly a molecule or species in a solution or fluid responds to a magnetic field is parameterized by the molar magnetic susceptibility, χ_m (cm^3/mole). For diamagnetic species, χ_m is between $(-1 \text{ to } -500) \times 10^{-6} \text{ cm}^3/\text{mole}$, and temperature independent. For paramagnetic species, χ_m ranges from 0 to

$+0.01 \text{ cm}^3/\text{mole}$, and, once corrected for its usually small diamagnetic component, varies inversely with temperature (Curie's Law).

While ions are monopoles and will either move with or against an electric field, depending on the sign of the ion, paramagnetic species are dipoles and will always be drawn into (aligned in) a magnetic field, independent of the direction of the magnetic vector. These dipoles will experience a net magnetic force if a field gradient exists. Because electrochemistry tends to involve single electron transfer events, the majority of electrochemical reactions should result in a net change in the magnetic susceptibility of species near the electrode.

Magnetic field effects on chemical systems can be broken down into three types: thermodynamic, kinetic, and mass transport. Macroscopic, thermodynamic effects are negligible, although local magnetic field effects may not be. Kinetically, both reaction rates and product distributions can be altered. Transport effects can lead to flux enhancements of several-fold. Quantum mechanical effects are also possible, especially on very short length scales, below 10 nm. The following summarizes what has been done with homogeneous fields applied to solutions and cells with external laboratory magnets.

Thermodynamics

A magnetic field applied homogeneously by placing a solution between the poles of a laboratory magnet will have a negligible nonexponential effect on the free energy of reaction. $dG_m = -0.5 d\chi_m B^2 \text{ J/mole}$, where dG_m is the change of the free energy of reaction due to the magnetic field, $d\chi_m$ is the difference in magnetic susceptibility of the products and reactants, and B is the magnetic induction in gauss. For the conversion of a diamagnetic species into a paramagnetic species, $d\chi_m \leq 0.01 \text{ cm}^3/\text{mole}$. In a 1 Tesla (T) (1 Tesla=10 kGauss) applied field, $|dG_m| \leq 0.05 \text{ J/mole}$. Even in the strongest laboratory fields of 10 T, the effect is negligible compared to typical free energies of reaction ($=\text{kJ/mole}$). These are macroscopic arguments for systems where the magnet is placed external to the cell and a uniform field is applied to the solution. Microscopically, it may be possible to argue that local fields in composites are substantial, and molecules in composites within a short distance of the source of the magnetic field experience strong local fields. For example, for a magnetic wire or cylinder, the magnetic field falls off over a distance, x , as x^{-3} . The field experienced by a molecule 1 nm from the magnet is roughly 10^{21} times larger than the field experienced at 1 cm. This argument is crude, but qualitatively illustrates the potential advantage of a microstructural magnetic composite. (As an example, in the magnetic/Nafion (DuPont) composites, a larger fraction of the redox species are probably transported through the 1.5 nm zone at the interface between the Nafion and the magnetic particles.) These redox species must therefore experience large magnetic fields in close proximity to the interface.

Kinetics

Reaction rates, k , are parameterized by a pre-exponential factor, A , and a free energy of activation, dG ; $k=A \exp[-dG/RT]$. An externally applied, homogeneous magnetic field will have little effect on dG , but can alter A . Nonadiabatic systems are susceptible to field effects. Magnetic fields alter the rate of free radical singlet-triplet interconversions by lifting the degeneracy of triplet states (affecting ΔG); rates can be altered by a factor of three in simple solvents. Because magnetic coupling occurs through both electronic

nuclear hyperfine interactions and spin-orbit interactions, rates can be nonmonotonic functions of the applied field strength. Photochemical and electrochemical luminescent rates can be altered by applied fields. For singlet-triplet interconversions, magnetic fields alter product distributions when they cause the rate of interconversion to be comparable to the rate at which free radicals escape solvent cages. These effects are largest in highly viscous media, such as polymer films and micellar environments. Larger effects should be observed as the dimensionality of the system decreases. For coordination complexes, photochemical and homogeneous electron transfer rates are altered by magnetic fields. Spin-orbit coupling is higher in transition metal complexes than organic radicals because of higher nuclear charge and partially unquenched orbital angular momentum of the d- or f-shell electrons. The rate of homogeneous electron transfer between $\text{Co}(\text{NH}_3)_6^{3+}$ and $\text{Ru}(\text{NH}_3)_6^{2+}$ is below that expected for diffusion controlled reactions; in a 7 T magnetic field, the rate is suppressed two to three-fold. It has been argued that $\Delta\chi_m$ (and ΔG_m) is set by the magnetic susceptibility of the products, reactants, and activated complex, and a highly paramagnetic activated complex accounts for the field effect. For reversible electron transfer at electrodes in magnetic fields, no significant effect is expected. For quasireversible electron transfer with paramagnetic and diamagnetic species, electron transfer rates and transfer coefficients (α) are unchanged by magnetic fields applied parallel to electrodes. Magnetic fields applied perpendicular to electrodes in flow cells generate potential differences, which just superimpose on the applied electrode potentials. Potentials of 0.25 V have been reported. Reversing the applied magnetic field reverses the sign of the potential difference. This effect does not change standard rate constants, only the applied potential.

Mass Transport

Magnetically driven mass transport effects have been studied in electrochemical cells placed between the poles of large magnets. Effects vary depending on the orientation of the electrode, the relative orientation of the magnetic field and the electrode, forced or natural convection, and the relative concentrations of the redox species and electrolyte. Three cases are illustrated in FIGS. 1, 2 and 3.

For a charged species moving by natural or forced convection parallel to an electrode and perpendicular to a magnetic field which is also parallel to the electrode, a Lorentz force is generated which moves the charged particle toward the electrode (FIG. 1). This magnetohydrodynamic effect is characterized by

$$F = q(E + v \times B) \quad (1)$$

where F , E , v , and B are vectors representing the Lorentz force on the charged species, the electric field, the velocity of the moving species, and the magnetic field, respectively; and q is the charge on the species. For flow cells and vertical electrodes, flux enhancements of a few-fold and reductions in the overpotential of a few tenths volts have been found in the presence of the magnetic field. Also, embedded in Equation 1 is the Hall effect; when a charged species moves through a perpendicular magnetic field, a potential is generated. This potential superimposes on the applied potential and causes migration in low electrolyte concentrations.

When the electrode and magnetic field are parallel to the earth, thermal motion leads to vortical motion at the electrode surface unless the field (B) and the current density (j)

are spatially invariant and mutually perpendicular (see FIG. 2). This is parameterized as:

$$F_v = c^4 [j \times B] \quad (2)$$

In Equation (2) F_v is the vector of magnetic force per volume and c is the speed of light. In general, these forces are smaller than Lorentz forces; flux enhancements of a few-fold and potential shifts of 10 to 20 mV are observed. Flux enhancements of paramagnetic and diamagnetic species are similar, but paramagnetic electrolytes enhance the flux of diamagnetic Zn^{2+} two-fold. Vortices suppress thermal motion and eddy diffusion.

The final configuration, shown in FIG. 3, is for the magnetic field perpendicular to the electrode surface, and, therefore, parallel to the electric field. Various, and sometimes inconsistent, results are reported for several configurations: for vertical electrodes in quiescent solution, flux enhancements of $\leq 1000\%$; for electrodes parallel to the earth with forced convection, flux retardations of 10%; and for electrodes parallel to the earth and no forced convection, both enhancements and no enhancements are reported.

The above summarizes the thermodynamic, kinetic, and mass transport effects for systems where the magnetic field is applied uniformly across a cell with an external magnet. None of these macroscopic effects predict or address properties dependent on the magnetic susceptibility of the redox species. Quantum mechanical effects may also be important, especially on short length scales.

Fuel Cells

Since the incomplete reduction of oxygen limits the efficiency of H_2/O_2 solid polymer electrolyte fuel cells, the cathode must be pressurized about five-fold over the anode.

Proton exchange membrane (PEM) fuel cell design is one which employs hydrogen as an anode feed and oxygen in air as a cathode feed. These fuels are decomposed electrolytically (to yield water) at electrodes typically modified with a noble metal catalyst. The hydrogen and oxygen are separated from each other by a proton exchange membrane (such as Nafion) to prevent thermal decomposition of the fuels at the noble metal catalyst. The reactions at the cathode and anode can be summarized as follows:

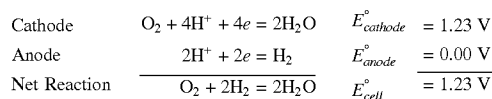

However, the fuel cell is typically run under non-equilibrium conditions, and, as such, is subject to kinetic limitations. These limitations are usually associated with the reaction at the cathode.

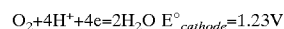

As the reaction at the cathode becomes increasingly kinetically limited, the cell voltage drops, and a second reaction path, the two electron/two proton reduction of oxygen to peroxide, becomes increasingly favored. This consumes oxygen in two electron steps with lower thermodynamic potential.

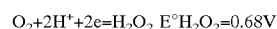

The standard free energy of this reaction is 30% of the free energy available from the four electron reduction of oxygen to water. The decrease in current associated with the decreased number of electrons transferred and the decreased cell potential couple to yield substantially lower fuel cell power output.

One approach to enhance the efficiency of the cathodic reaction is to increase the concentration (pressure) of the feeds to the cathode—protons and oxygen—so as to enhance the flux (i.e., the reaction rate at the cathode in moles/cm²s) at the cathode. The proton flux is readily maintained at a sufficiently high value by the proton exchange membrane (usually Nafion) so as to meet the demand set by the cathode reaction. Normally, the method of enhancing the flux and biasing the reaction to favor the formation of water is to pressurize the air feed to the cathode. Pressures of 5–10 atmospheres are typical.

The need to pressurize air to the cathode in PEM fuel cells has been a major obstacle in the development of a cost effective fuel cell as a replacement for the internal combustion engine e.g., in a vehicle. In particular, pressurization of the cathode requires compressors. In transportation applications, power from the fuel cell is needed to run the compressor. This results in approximately 15% reduction in the power output of the total fuel cell system.

By developing a passive pressurization method for a fuel cell, the mechanical pumps could be eliminated from the fuel cell system. This has numerous advantages. The weight of a fuel cell would be decreased almost 40% by eliminating mechanical pumps. With the elimination of the parasitic loss of running the pumps, and improving cathode performance, the fuel cells would provide a higher energy and power density. Any potential shift at the electrode surface driven by the magnetic components can be exploited to enhance the voltage output of the fuel cell, and to overcome the poor kinetics of the cathode. Eliminating the pumps also eliminates the only moving parts of the fuel cell, and thereby, the likelihood of fuel cell failure is drastically reduced.

In current fuel cell design, the cathode is pressurized to approximately five times the pressure of the anode. This pressurization constrains the design of the fuel cell to be sufficiently rigid as to support this pressure. In a magnetically based, passive pressurization scheme, the need for the rigid structure is eliminated. This has two major advantages. First, the weight and bulk of the fuel cell is decreased. Second, the fuel cell is now a flexible device. The flexibility can be exploited in various ways, including placing fuel cells into unusual geometries and structures, thereby exploiting space in structures and devices which might otherwise be lost. Also, the flexible nature of the fuel cell allows a single structure to be divided readily into several smaller cells, which can be connected into different parallel and serial configurations to provide variable voltage and current outputs. Such a division is more complicated in the more rigid structures of a pressurized fuel cell because the encasing walls limit access to the fuel cell electrodes.

SUMMARY OF THE INVENTION

It is therefore an object of the invention to provide an improved electrode.

Another object of the invention is to provide a coating on an electrode to enhance the flux of magnetic species to the electrode.

Another object of the invention is to provide a separator to separate magnetic species from each other dependent upon magnetic susceptibility.

Another object of the invention is to provide a method for making a coating for an electrode to improve the flux of magnetic species to the electrode.

Another object of the invention is to provide an improved fuel cell.

Another object of the invention is to provide an improved cathode in a fuel cell.

Another object of the invention is to provide an improved battery.

Another object of the invention is to provide an improved membrane sensor.

Another object of the invention is to provide an improved flux switch.

Another object of the invention is to provide an improved fuel cell cathode with passive oxygen pressurization.

Another object of the invention is to provide an improved separator for separating paramagnetic species from diamagnetic species.

Another object of the invention is to provide an improved electrolytic cell.

Another object of the invention is to provide an improved electrolytic cell for an electrolyzable gas.

Another object of the invention is to provide an improved graded density composite for controlling chemical species transport.

Another object of the invention is to provide an improved dual sensor.

One advantage of the invention is that it can enhance the flux of paramagnetic species to an electrode.

Another advantage of the invention is that it can enhance the flux of oxygen to the cathode in a fuel cell, equivalent to passive pressurization.

Another advantage of the invention is that it can separate paramagnetic, diamagnetic, and nonmagnetic chemical species from a mixture.

Another advantage of the invention is that it can separate chemical species according to chemical, viscosity, and magnetic properties.

Another advantage of the invention is that it can take advantage of magnetic field gradients in magnetic composites.

Another advantage of the invention is that it can be designed to work with internal or external magnetic fields, or both.

One feature of the invention is that it includes a magnetically modified electrode.

Another feature of the invention is that it includes magnetic composites made from ion exchange polymers and non-permanent magnet microbeads with magnetic properties which are susceptible to externally applied magnetic fields.

Another feature of the invention is that it includes magnetic composites made from ion exchange polymers and organo-Fe (superparamagnetic or ferrofluid) or other permanent magnetic and nonpermanent magnetic or ferromagnetic or ferrimagnetic material microbeads which exhibit magnetic field gradients.

These and other objects, advantages and features are accomplished by a separator arranged between a first region containing a first type of particle and a second type of particle and a second region, comprising: a first material having a first magnetism; a second material having a second magnetism; a plurality of boundaries providing a path between the first region and the second region, each of the plurality of boundaries having a magnetic gradient within the path, the path having an average width of approximately

one nanometer to approximately several micrometers, wherein the first type of particles have a first magnetic susceptibility and the second type of particles have a second magnetic susceptibility, wherein the first and the second magnetic susceptibilities are sufficiently different that the first type of particles pass into the second region while most of the second type of particles remain in the first region.

These and other objects, advantages and features are also accomplished by the provision of a cell, comprising: an electrolyte including a first type of particles; a first electrode arranged in the electrolyte; and a second electrode arranged in the electrolyte wherein the first type of particles transform into a second type of particles once the first type of particles reach the second electrode, the second electrode having a surface with a coating which includes: a first material having a first magnetism; a second material having a second magnetism; a plurality of boundaries providing a path between the electrolyte and the surface of the second electrode, each of the plurality of boundaries having a magnetic gradient within the path, the path having an average width of approximately one nanometer to approximately several micrometers, wherein the first type of particles have a first magnetic susceptibility and the second type of particles have a second magnetic susceptibility, and the first and the second magnetic susceptibilities are different.

These and other objects, advantages and features are also accomplished by the provision of a method of making an electrode with a surface coated with a magnetic composite with a plurality of boundary regions with magnetic gradients having paths to the surface of the electrode, comprising the steps of: mixing a first component which includes a suspension of at least approximately 1 percent by weight of inert polymer coated magnetic microbeads containing between approximately 10 percent and approximately 90 percent magnetizable material having diameters at least 0.5 micrometers in a first solvent with a second component comprising at least approximately 2 percent by weight of an ion exchange polymer in a second solvent to yield a casting mixture or mixed suspension; applying the mixed suspension to the surface of the electrode, the electrode being arranged in a magnetic field of at least approximately 0.5 Tesla and being oriented approximately 90 degrees with respect to the normal of the electrode surface; and evaporating the first solvent and the second solvent to yield the electrode with a surface coated with the magnetic composite having a plurality of boundary regions with magnetic gradients having paths to the surface of the electrode.

These and other objects, advantages and features are further accomplished by a method of making an electrode with a surface coated with a composite with a plurality of boundary regions with magnetic gradients having paths to the surface of the electrode when an external magnetic field is turned on, comprising the steps of: mixing a first component which includes a suspension of at least 5 percent by weight of inert polymer coated microbeads containing between 10 percent and 90 percent magnetizable nonpermanent magnetic material having diameters at least 0.5 micrometers in a first solvent with a second component comprising at least 5 percent by weight of an ion exchange polymer in a second solvent to yield a casting mixture or mixed suspension; applying the mixed suspension to the surface of the electrode; evaporating the first solvent and the second solvent to yield the electrode with a surface coated with the composite having a plurality of boundary regions with magnetic gradients having paths to the surface of the electrode when an external magnet is turned on.

These and other objects, advantages and features are also accomplished by an electrode for channeling flux of mag-

netic species comprising: a conductor; a composite of a first material having a first magnetism and a second material having a second magnetism in surface contact with the conductor, wherein the composite comprises a plurality of boundaries providing pathways between the first material and the second material, wherein the pathways channel the flux of the magnetic species through the pathways to the conductor.

These and other objects, advantages and features are further accomplished by an electrode for effecting electrolysis of magnetic species comprising: a conductor; and magnetic means in surface contact with the conductor for enhancing the flux of the magnetic species in an electrolyte solution to the conductor and thereby effecting electrolysis of the magnetic species.

These and other objects, advantages and features are further accomplished by an electrode for effecting electrolysis of magnetic species comprising: a conductor; and means in surface contact with the conductor for enhancing the flux of the magnetic species to the conductor and thereby effecting electrolysis of the magnetic species.

These and other objects, advantages and features are yet further accomplished by an electrode for electrolysis of magnetic species comprising: a conductor; a composite magnetic material in surface contact with the conductor, the composite magnetic material having a plurality of transport pathways through the composite magnetic material to enhance the passage of the magnetic species to the conductor and thereby effecting electrolysis of the magnetic species.

These and other objects, advantages and features are also accomplished by a system, comprising: a first electrolyte species with a first magnetic susceptibility; a second electrolyte species with a second magnetic susceptibility; and a means for channeling the first electrolyte species with a first magnetic susceptibility preferentially over the second electrolyte species with a second magnetic susceptibility, wherein the means comprises a first material having a first magnetism forming a composite with a second material having a second magnetism.

These and other objects, advantages and features are also accomplished by a system for separating first particles and second particles with different magnetic susceptibilities comprising: a first magnetic material with a first magnetism; and a second magnetic material with a second magnetism working in conjunction with the first magnetic material to produce magnetic gradients, wherein the magnetic gradients separate the first particles from the second particles.

These and other objects, advantages and features are accomplished by a composite material for controlling chemical species transport comprising: an ion exchanger and a graded density layer, wherein the ion exchanger is sorbed into the graded density layer.

These and other objects, advantages and features are further accomplished by a magnetic composite material for controlling magnetic chemical species transport according to the magnetic susceptibility comprising: an ion exchanger; a polymer coated magnetic microbead material; and a graded density layer, wherein the ion exchanger and the polymer coated magnetic microbead material are sorbed into the graded density layer.

These and other objects, advantages and features are further accomplished by a composite material for controlling chemical species viscous transport comprising: an ion exchanger; a graded viscosity layer, wherein the ion exchanger is sorbed into the graded viscosity layer.

These and other objects, advantages and features are further accomplished by a magnetic composite material for controlling magnetic chemical species transport and distribution comprising: an ion exchanger; a polymer coated magnetic microbead material; and a graded density layer, wherein the ion exchanger and the polymer coated magnetic microbead material are sorbed into the graded density layer forming a gradient in the density of the polymer coated magnetic microbead material substantially perpendicular to a density gradient in the graded density layer.

These and other objects, advantages and features are further accomplished by a magnetic composite material for controlling magnetic chemical species transport and distribution comprising: an ion exchanger; a polymer coated magnetic microbead material; and a graded density layer, wherein the ion exchanger and the polymer coated magnetic microbead material are sorbed into the graded density layer forming a gradient in the density of the polymer coated magnetic microbead material substantially parallel to a density gradient in the graded density layer.

These and other objects, advantages and features are also accomplished by an ion exchange composite with graded transport and chemical properties controlling chemical species transport comprising: an ion exchanger; and a staircase-like graded density layer having a first side and a second side, wherein the ion exchanger is one of sorbed into the graded density layer and cocast on the graded density layer and the staircase-like graded density layer and the ion exchanger are contained with the first side and the second side, wherein the first side is in closer proximity to the source of the chemical species and the second side is more distal to the source of the chemical species, and wherein the staircase-like graded density layer has lower density toward the first side and higher density toward the second side, substantially increasing in density in a direction from the first side toward the second side.

These and other objects, advantages and features are also accomplished by an ion exchange composite with graded transport and chemical properties controlling chemical species transport comprising: an ion exchanger; and a staircase-like graded density layer having a first side and a second side, wherein the ion exchanger is one of sorbed into the graded density layer and cocast on the graded density layer, and the ion exchanger and the staircase-like graded density layer are contained within the first side and the second side, wherein the first side is in closer proximity to the source of the chemical species and the second side is more distal to the source of the chemical species, and wherein the staircase-like graded density layer has higher density toward the first side and lower density toward the second side, substantially decreasing in density in a direction from the first side toward the second side.

These and other objects, advantages and features are accomplished also by a dual sensor for distinguishing between a paramagnetic species and a diamagnetic species comprising: a magnetically modified membrane sensor; and an unmodified membrane sensor, wherein the magnetically modified membrane sensor preferentially enhances the concentration of the allows the detection of the paramagnetic species over the diamagnetic species and the unmodified membrane sensor enhances the concentration of and allows the detection of the diamagnetic species and the paramagnetic species, enabling the measurement of the concentration of at least the paramagnetic species.

These and other objects, advantages and features are further accomplished by a dual sensor for distinguishing

between a paramagnetic species and a nonmagnetic species comprising: a magnetically modified membrane sensor; an unmodified membrane sensor, wherein the magnetically modified membrane sensor preferentially enhances the concentration of and allows the detection of the paramagnetic species over the nonmagnetic species and the unmodified membrane sensor enhances the concentration of and allows the detection of the nonmagnetic species and the paramagnetic species, enabling the measurement of the concentration of at least the paramagnetic species.

These and other objects, advantages and features are further accomplished by a dual sensor for distinguishing between a first diamagnetic species and a second diamagnetic species comprising: a magnetically modified membrane sensor; and a differently magnetically modified membrane sensor, wherein the magnetically modified membrane sensor preferentially enhances the concentration of and allows the detection of the first diamagnetic species over the second diamagnetic species and the differently magnetically modified membrane sensor enhances the concentration of and allows the detection of the second paramagnetic species and the diamagnetic species, enabling the measurement of the concentration of at least the first diamagnetic species.

These and other objects, advantages and features are further accomplished by a dual sensor for distinguishing between a first paramagnetic species and a second paramagnetic species comprising: a magnetically modified membrane sensor; and a differently magnetically modified membrane sensor, wherein the magnetically modified membrane sensor preferentially enhances the concentration of and allows the detection of the first paramagnetic species over the second paramagnetic species and the differently magnetically modified membrane sensor enhances the concentration of and allows the detection of the second paramagnetic species and the first paramagnetic species, enabling the measurement of the concentration of at least the first paramagnetic species.

These and other objects, advantages and features are further accomplished by a dual sensor for distinguishing between a diamagnetic species and a nonmagnetic species comprising: a magnetically modified membrane sensor; and an unmodified membrane sensor, wherein the magnetically modified membrane sensor preferentially enhances the concentration of and allows the detection of the diamagnetic species over the nonmagnetic species and the unmodified membrane sensor enhances the concentration of and allows the detection of the nonmagnetic species and the diamagnetic species, enabling the measurement of the concentration of at least the diamagnetic species.

These and other objects, advantages and features are further accomplished by a flux switch to regulate the flow of a redox species comprising: an electrode; a coating on the electrode, wherein the coating is formed from a composite comprising: a magnetic microbead material with aligned surface magnetic field; an ion exchange polymer; and an electro-active polymer in which a first redox form is paramagnetic and a second redox form is diamagnetic, wherein the flux switch is actuated by electrolyzing the electro-active polymer from the first redox form ordered in the magnetic field established by the coating to the second redox form disordered in the magnetic field.

These and other objects, advantages and features are also accomplished by a flux switch to regulate the flow of a chemical species comprising: an electrode; and a coating on the electrode, wherein the coating is formed from a composite comprising: a non-permanent magnetic microbead

material; an ion exchanger polymer; and a polymer with magnetic material contained therein in which a first form is paramagnetic and a second form is diamagnetic, wherein the flux switch is actuated by reversibly converting from the paramagnetic form to the diamagnetic form when an externally applied magnetic field is turned on or off.

The above and other objects, advantages and features of the invention will become more apparent from the following description thereof taken in conjunction with the accompanying drawings.

BRIEF DESCRIPTION OF THE DRAWINGS

FIG. 1 shows the influence of electrode orientation and solvent motion on magnetohydrodynamic fluid motion for one geometry.

FIG. 2 shows the influence of electrode orientation and solvent motion on magnetohydrodynamic fluid motion for a second geometry.

FIG. 3 shows the influence of electrode orientation and solvent motion on magnetohydrodynamic fluid motion for a third geometry.

FIGS. 4A and 4B show plots of m values for neutron-track etched polycarbonate/Nafion composites versus functions of pore diameter, d .

FIGS. 5A and 5B show the surface diffusion model assuming no limitations to the transport rate in the radial direction.

FIGS. 6A and 6B show the surface diffusion model including radial migration.

FIGS. 7A and 7B show m values of hydroquinone through polystyrene/Nafion composites for ratios of surface area of the microbeads to volume of Nafion.

FIG. 8 shows an analysis of fractal diffusion along the surface of the microbeads in polystyrene Microbead/Nafion composites.

FIG. 9 shows the relative flux of redox species on the y -axis, where the maximum cyclic voltammetric current for a composite with magnetic microbeads is normalized by the maximum cyclic voltammetric current for a Nafion film containing no magnetic material, with the ratio giving the flux enhancement.

FIG. 10 shows m values for $\text{Ru}(\text{NH}_3)_6^{3+}$ as a function of volume fraction of microbeads in magnetic and nonmagnetic composites.

FIG. 11 shows flux increases with magnetic content of microbeads for $\text{Ru}(\text{NH}_3)_6^{3+}$.

FIGS. 12A, 12B, and 12C show cyclic voltammetric results for the reversible species $\text{Ru}(\text{NH}_3)_6^{3+}$ and $\text{Ru}(\text{bpy})_3^{2+}$ and for the quasireversible species hydroquinone.

FIG. 13 shows a plot of the flux for seven redox species that is used for predicting a roughly five-fold flux enhancement of oxygen through a 15% magnetic Nafion composite over Nafion.

FIG. 14 shows a plot of the flux of $\text{Ru}(\text{NH}_3)_6^{3+}$ in magnetic bead/Nafion composites increasing as the fraction of magnetic beads increases.

FIG. 14A shows a plot of the paramagnetic effective moments of lanthanide metals and compounds as a function of the number of f -shell electrons.

FIG. 14B shows a plot of the paramagnetic effective moments of actinide metals and compounds as a function of the number of f -shell electrons.

FIG. 14C shows a plot of the magnetic moments of d -shell transition metals as a function of the number of d -shell electrons.

FIG. 14D shows a series of vats separated by magnetic separators used to separate mixtures to increase constituent purity according to the instant invention.

FIG. 15A shows a simplified representation used to describe how magnetic microboundaries influence a standard electrochemical process.

FIG. 15B shows a simplified representation of embodiments of the invention placed in an externally applied magnetic field provided by an electromagnet to alter the magnetic properties of those embodiments, where the field may be turned on or off, or it may be oscillated.

FIG. 16 shows a simplified diagram of a separator with no electrode or conductive substrate which separates a mixture of particles between a first solution and second solution.

FIG. 16A shows a series of vats separated by magnetic separators used to separate mixtures to increase constituent purity similar to FIG. 14D, but which uses a ligand to form complexes that aid in the separation according to the present invention.

FIG. 16B shows a series of vats separated by magnetic separators used to separate mixtures to increase constituent purity similar to FIG. 14D, but which uses a ligand associated with the magnetic separators to form complexes that aid in the separation according to the present invention.

FIG. 16C shows a series of vats separated by magnetic separators used to separate mixtures that combines separation similar to FIG. 14D with separation using a ligand to form complexes that aid in the separation according to the present invention.

FIG. 16D shows two vats separated by a magnetic separator used to separate mixtures that combines separation similar to FIG. 14D with separation using a ligand to form complexes that aid in the separation along with particle precipitation. FIG. 16E shows fuel cells 1220 in arrangements.

FIG. 17 is a short summary of steps involved in a method of making an electrode according to two embodiments of the invention.

FIGS. 18A and 18B show a flux switch 800 to regulate the flow of a redox species according to yet another embodiment of the invention.

FIG. 19 shows a dual sensor 900 for distinguishing between a first species (particles A) and a second species (particles B).

FIG. 20 shows a cell 201 according to another embodiment of the invention. An embodiment of the chromatographic technique is shown in FIG. 20A. FIG. 20B shows rough magnetic field lines in the iron wire. FIG. 20C shows a method for the technique of FIG. 20A.

DETAILED DESCRIPTION OF PREFERRED EMBODIMENTS

Interfacial Gradients in General

It has been found that interfacial gradients of concentration, charge, dielectric constant, and potential tend to establish strong, interfacial forces which decay over a microstructural distance (1 to 100 nm). (For example, for an applied potential of 10 mV to 100 mV past the potential of zero charge at an electrode in 0.1 M aqueous electrolyte, the interfacial potential gradient (electric field) is 10^3 V/cm to 10^6 V/cm, but it decays over a distance of about 1 nm.) In a homogeneous matrix, with few interfaces, interfacial gradients have a negligible effect on bulk material properties. However, in a microstructured matrix where the ratio of surface area to volume is high, interfacial gradients can have

a large effect on, or even dictate, the properties of a composite. Models appropriate to the description of bulk materials have been found to be unsatisfactory when applied to these composites. Moreover, such composites provide an opportunity to design matrices to perform functions and exhibit properties not found in homogeneous materials, as will be discussed.

The effects of gradients, associated with the interfaces between the ion exchanger and its support matrix, to enhance the transport of ions and molecules have been studied in ion exchange polymer composites. The composites were formed by sorbing ion exchange polymers into high surface area substrates with well-established geometries. The flux of solutes through the composites was determined voltammetrically. When the solute flux through the ion exchange portion of the composites and the flux through simple films of the ion exchanger were compared, flux enhancements were observed for the composites. These enhancements were often greater than an order of magnitude. Consistently, the ratio of surface area of the substrate to the volume of sorbed ion exchanger (SA/Vol) has been the critical factor in quantifying the flux enhancements. The flux enhancement characteristics were found to be dominated by the interface between the ion exchanger and the support. Several interfacial gradients have so far been identified as important: concentration gradients, leading to surface diffusion; electric potential gradients, leading to migration; and magnetic field gradients, leading to flux enhancements and electric potential shifts at electrodes.

Forming Composites

Composites were made by intimately mixing two or more components to form a heterogeneous matrix as will be discussed in more detail below. While composites retain some characteristics of their components, properties distinct from those of the starting materials have been demonstrated that make composites of special interest.

Results

The impact of microstructure on transport and selectivity in ion exchange polymers and their composites has been found to be significant. Novel characteristics arose not from the individual components of the composites, but from gradients established at the interfaces between the components. Ion exchange polymers with inherent microstructure, such as Nafion, exhibit superior transport, selectivity, and stability characteristics compared to polymers with no inherent microstructure, such as poly(styrene sulfonate). When ion exchange polymers were supported on inert substrates with microstructural (5 to 100 nm) features similar in length scale to the microstructural features of the ion exchanger (e.g., 5 nm micelles in Nafion), the structure of the ion exchanger was disrupted in an ordered manner. The relationship between the flux characteristics of the composites and the microstructure imposed by the substrates has yielded information about how microstructure contributes to the properties of ion exchangers. This relationship allows the specification of design paradigms for tailoring composites with specific transport and selectivity characteristics.

Surface Diffusion

The first composites studied in this regard were formed by sorbing Nafion into the collinear cylindrical pores of neutron track etched polycarbonate membranes. The ion exchange polymer, Nafion is a perfluorinated, sulfonic acid polymer with the following structure:

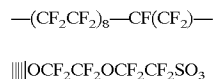

The SO_3 groups adsorb on the inert substrates to form a loosely packed monolayer of perfluorinated alkyl chains, $\text{OCF}_2\text{CF}_2\text{OCF}_2\text{CF}_2\text{SO}_3$ shown above in boldface. This creates a unique interfacial zone approximately 1 to 2 nm thick along the edge formed between the ion exchange polymer and the inert substrate. In systems with high ratio of surface area to volume, a large fraction of the molecules and ions which passed through these composites actually moved through this interfacial zone. That is, it was found that the molecules and ions have higher flux in this thin interfacial zone, where the interfacial fields were strongest.

In a given membrane, all pores had approximately the same diameter, d , ranging between 15 and 600 nm. The flux of electro-active species through the composites was determined by rotating disk voltammetry. In rotating disk voltammetry, the product km (cm^2/s) parameterizes the flux of a redox species through the Nafion portion of the composites, where k is the partition coefficient of the species into the Nafion and m (cm^2/s) is its mass transport coefficient. Simple Nafion films cast directly onto the electrode were also studied. The resulting plots of km as a function of $\log(d)$ are shown in FIG. 4A. As indicated in FIG. 4A, as the pore diameter decreased towards 30 nm, the flux through the Nafion portion increased as much as 3600% over the simple films. These studies showed that the interface between Nafion and a support matrix was pivotal in determining the flux characteristics of the composites.

The flux enhancement model proposed here depends on the interface formed between the Nafion and the polycarbonate providing a facile transport pathway to the electrode for the redox species. Bulk Nafion located in the center of the pore has a smaller transport coefficient (m) than the support matrix wall, but provided a volume to extract redox species from the center of the pore to feed the wall transport zone. The critical parameter for flux enhancement was found to be (for a cylindrical cross section path) the ratio of the surface area of the wall providing facile transport ($\pi d\lambda$), where λ is the layer thickness, to the volume of Nafion feeding the interface ($\pi d^2\lambda/4$), i.e., $4/d$. Plots of km versus $1/d$ are shown in FIG. 4B. Note that the plots are linear in FIG. 4B for $d \geq 30$ nm, and with the exception of dopamine, the intercepts as $d \rightarrow \infty (1/d \rightarrow 0)$ correspond to km for bulk Nafion.

Predictive models of how interfaces and their associated concentration, field, etc. gradients dictate interface properties and function are provided below and further aid in the design of new composites tailored for specific applications. A simple surface diffusion model assuming no limitations to the transport rate in the radial direction is outlined. FIGS. 5A and 5B show the simple model where transport in the radial direction is not rate limiting. In the model, J_{comp} is the total flux through the composites, J_{Nmc} is the flux through an empty pore, and J_{bulk} and J_{wall} are the fluxes in the bulk (center) of the pore and along the surface of the pore, respectively. To analyze the flux, as in FIG. 4B, J_{bulk} and J_{wall} must be normalized to the cross sectional area of the pore used to determine km , the product of the effective extraction and transport coefficients. From the final equation, the plot in FIG. 4B can be interpreted to have the slope and intercept shown in FIGS. 5A and 5B. If δ , the thickness of the interfacial zone, is taken as 1.5 nm, the values cited for $\kappa_{wall}m_{wall}$ and $\kappa_{bulk}m_{bulk}$ are found. The

diffusion coefficients of each species in solution are also listed for comparison. In general, $\kappa_{wall}m_{wall}=(10 \text{ to } 10^3)\times \kappa_{bulk}m_{bulk}=(1\times 10)\times D_{sole}$. In other words, for an interfacial zone thickness, δ , of 1.5 nm, $\kappa_{wall}m_{wall}$ is up to one order of magnitude higher than D_{sole} , and one to two orders of magnitude higher than $\kappa_{bulk}m_{bulk}$.

The interfacial transport zone occurs because of the irreversible exchange of Nafion sulfonic acid groups to polycarbonate surface sites to form a monolayer of inactive sulfonic acid groups. The side chains linking the sulfonic acid sites to the Nafion backbone form a loosely packed monolayer along the pore wall which facilitates the flux through the transport zone compared to transport through the tortuous environment of bulk Nafion. Given the length of the chains, a δ value of about 1.5 nm is consistent with $\kappa_{wall}m_{wall}$ (and km/D_{sole}) decreasing as transport is more hindered with increasing diameter of the redox species; i.e., $\kappa_{wall}m_{wall}$ decreases as H_2Q (0.6 nm) $>$ Ru(NH₃)₆³⁺ (0.8 nm) $>$ DOP⁺ (0.8 nm) $>$ FerN⁺ (1 nm). Discrimination between these species has also been observed based on molecular shape in the neutron track-etched composites. For example, disk shaped molecules exhibit higher flux than comparably sized spherical molecules.

Radial Migration

The pore walls have a surface charge density of $-0.2 \mu\text{C}/\text{cm}^2$. For a 30 nm pore diameter composite, the corresponding charge is 0.5% of the total charge in the pore, and will have negligible effect on the number of cations extracted from the solution to move into the pore. However, the surface charge establishes a potential gradient (electric field) from the pore to the wall which tends to move positively charged ions radially outward from the center of the pore to the wall. An issue is whether this radial, interfacial potential gradient can be coupled to the concentration gradient along the wall to enhance solute flux to the electrode, as illustrated in FIGS. 6A and 6B.

The model was tested by varying the concentration of the electrolyte, nitric acid, from 0.50 to 0.01 M, for fixed dopamine concentration (2 mM). Flux was determined by rotating disk voltammetry at 400 rpm for the bare electrode and at infinite rotation rate for the modified electrodes (see Table 1). The electrolyte concentration did not dramatically affect the flux for the bare electrode, the 30 nm membrane containing no Nafion, and the Nafion film.

TABLE 1

[H ⁺]	Flux (nmol/cm ² s) for Dopamine Oxidation at Various [H ⁺]			
	Flux _{unmodified} ^{400 rpm}	Flux _{30 nm}	Flux _{Film} ^{Nafion}	Flux _{30 nm} ^{Nafion}
0.50M	38.6	54.8	4.2	2.4
0.10M	36.7	57.5	4.3	10.5
0.01M	44.6	73.1	—	39.0

However, for the 30 nm Nafion composite a fifty-fold decrease in electrolyte concentration led to $>1600\%$ increase in flux. Coupling of radial flux, driven by the interfacial potential gradient, to surface diffusion generates the enhancement. No enhancements were observed for a similar study of neutral hydroquinone. It should be noted that only charged species move by migration; dopamine is charged, while hydroquinone is not.

Since the selectivity coefficient for dopamine over protons is about 500 in Nafion, decreasing the electrolyte concentration fifty-fold only decreases the dopamine con-

centration by 10%. The dramatic effect produced by varying the proton concentration means that the protons, not the dopamine, compensate the wall charge to establish the interfacial potential gradient and enhance the radial flux of dopamine. This is possible because the dopamine, a cationic amine, is heavily ion paired to the sulfonic acid sites. With a dielectric constant of 20, substantial ion pairing can be anticipated in Nafion. Ion pairing may explain why the flux of cationic amines is lower than neutral hydroquinone as can be seen with reference to FIGS. 4A and 4B which show m values for neutron-track etched polycarbonate/Nafion composites. FIG. 4A shows km versus $\log(d)$, where d is the pore diameter, km increases above the values for bulk Nafion as d approaches 30 nm. The concentrations are 2 mM redox species and 0.1 M electrolyte for RuN⁺—Ruthenium (II) hexamine (\square), H₂Q—Hydroquinone (Δ, ∇), DOP⁺—Dopamine (\circ), and FerN⁺—Trimethylamminomethyl ferrocene (\diamond). The electrolyte is H₂SO₄ in all cases except for DOP⁺ and H₂Q (∇). Lines represent no model and are only intended to indicate the trend in the data. FIG. 4B shows km versus d^{-1} , where $4d^{-1}$ is the surface area of the pore/volume of Nafion in the pore. As illustrated in FIGS. 6A and 6B, the slopes in FIG. 4B are indicative of the surface flux, and the intercept corresponds to the flux in bulk Nafion. Note, all the redox species except hydroquinone are charged amines, and all have lower flux than hydroquinone.

Vapor Phase Electrochemistry/Microstructure in Two-Dimensions

One way to alter microstructure is to reduce the conduction matrix from three to two-dimensions. A two-dimensional system is made by sulfonating the nonionic, polymeric insulator between the electrodes of a microelectrode assembly. Conduction across the surface cannot be studied in either an electrolyte solution or a pure solvent as the liquid provides a conductive path between the electrodes. However, by supporting the microelectrode assembly in an evacuated flask, and injecting hydrogen or hydrogen chloride and a small amount (μL 's) water, conduction can be studied by electrolyzing the gas. In these lower dimensional systems, the role of the ion exchange site and its concentration, as well as the role of water in ionic conduction can be studied. Preliminary studies were performed to study conduction through solvent layers adsorbed from the vapor phase across the nonionic surface of a microelectrode assembly. Electrolysis of gas phase solvents required the solvent to adsorb at greater than monolayer coverage to bridge the gap between the electrodes. Solvents with high autoprotolysis and acidity constants sustain higher currents than solvents less able to generate ions. These studies provided information above gas phase electrochemical detection and systems as well as atmospheric corrosion.

Composites Formed with Polymerized Microspheres

To test the generality of flux enhancement by interfacial forces, composites of Nafion and polymerized polystyrene microspheres were formed; diameters of 0.11 to 1.5 μm were used. FIGS. 7A and 7B show km of hydroquinone through polystyrene microbead/Nafion composites versus ratios of surface area of the microbeads to volume of Nafion. In particular, values of km found for various ratios of bead surface area for transport to volume of Nafion for extraction (SA/Vol) are shown for three different bead diameters. As for the neutron track etched composites, linear plots were found, at least for the larger sizes, with intercepts compa-

rable to bulk Nafion. Of these sizes, 0.37 μm beads exhibited the largest flux enhancement (600%). FIG. 7A shows results for composites formed with single size beads, where the ratio of surface area to volume was varied by varying the volume fraction of beads in the composites. Positive slopes are shown consistent with flux enhancement by surface diffusion along the surface of the beads. The intercepts are consistent with transport through bulk Nafion.

The fraction of microbeads or in the composite can be varied and different sizes mixed to allow a continuous range of SA/Vol. In particular, FIG. 7B shows results for composites for a range of SA/Vol with 50% total fraction of Nafion by volume in the film. k_m increases as SA/Vol increases to about $3.5 \times 10^5 \text{ cm}^{-1}$, analogous to $1.3 \times 10^6 \text{ cm}^{-1}$ found for the neutron track etched composites (FIG. 4A). Scanning electron micrographs of the 50% Nafion, single bead size composites showed packing of the 0.11 μm beads was different and may account for the lower k_m values found for $d^{-1} > 3.5 \times 10^5 \text{ cm}^{-1}$, where 0.11 μm beads were used. FIG. 7B shows results for composites formed with 50% Nafion by volume. The ratio of surface area to volume was varied by making composites with beads of the same size and with beads of two different sizes. Flux increases as the ratio of surface area to volume increases to $3.5 \times 10^5 \text{ cm}^{-1}$; at the highest ratio, the composite contains 0.11 μm beads.

From the scanning electron micrographs, composites of beads larger than 0.11 μm exhibit the self-similarity typical of fractal materials. When $\ln(k_m)$ for these beads is plotted versus $\log(d)$, where d is the bead diameter, a linear plot with a slope of -0.733 was obtained; k_m versus $d^{-0.733}$ is shown in FIG. 8. For diffusion on a fractal of finitely ramified structure (e.g., the Sierpinski gasket), this is the power dependence expected for diffusion in a two-dimensional system. Thus, microbead composites exhibit transport typical of fractal diffusion along the microbead surface. This system confirms that surface diffusion provides a mechanism of flux enhancement. It also introduces the concept of fractal transport processes and the importance of surface dimensionality in ion exchange composites.

Poly(4-Vinylpyridine) Composites Formed on Neutron Track Etched Membranes

To investigate surface diffusion in other ion exchangers, composites were formed of protonated poly(4-vinylpyridine), PVP, and neutron track etched membranes. Flux enhancements in these composites also increased as the ratio of surface area of the pores to volume of PVP decreased. This result is consistent with the results found for Nafion composites, where facile surface transport enhanced flux.

Thermal Processing of Nafion

While commercial Nafion is heat pressed, a process that yields inverted micelles, the vast majority of academic studies of Nafion have been performed on cold cast Nafion which produces normal micelles. A study of the mechanical properties of Nafion hot cast from organic solvents has been reported. Attempts have been made to hot cast Nafion films with microwave heating. In the highly ionic casting solution, the glass transition temperature of Nafion (105°C .) should be reached as the water evaporates. Plots of flux as a function of the time microwaved have a break at approximately 15 minutes. The flux changed by no more than a factor of three, with a decrease in the flux of hydroquinone, and from preliminary studies, an increase in the flux of $\text{Ru}(\text{NH}_3)_6^{3+}$. This may indicate different transport mecha-

nisms for the two species in the film. Microwaved, cold cast and commercial hot cast films have been compared.

Magnetic, Demagnetized, and Nonmagnetic Composites

Polystyrene-coated, 1 to 2 μm Fe/Fe oxide (nonpermanent magnetic material) or organo-Fe (superparamagnetic or ferrofluid or permanent magnetic) microbeads are available (Bangs Labs, Polyscience, or Delco-Remy) as a 1% suspension in water, and Nafion (C.G. Processing) is available as a 5% suspension in alcohol/water. (Other inert or active polymer coatings besides polystyrene could be employed as well, and in nonaqueous environments, it is possible to eliminate the polymer coating completely if, for example, its purpose is normally only to prevent oxidation in an aqueous environment). This discussion holds for superparamagnetic or ferrofluid or permanent magnetic or nonpermanent magnetic or ferromagnetic or ferrimagnetic material microbeads in general. This discussion also holds for other magnets and other magnetic materials which include, but are not limited to superconductors, and magnetic materials based on rare earth metals such as cobalt, copper, iron, samarium, cerium, aluminum and nickel, and other assorted metal oxides, and magnetic materials based on neodymium, e.g., magnequench, which contains iron and boron in addition to neodymium. The polymer coatings are required for use of these microbeads in an aqueous environment to prevent oxidation, but in a nonaqueous environment the polymer coating may not be required.

Magnetic composites incorporating organo-Fe material microbeads are formed by casting appropriate volumes of each suspension onto an electrode centered inside a cylindrical magnet (5 cm inside diameter, 6.4 cm outside diameter, 3.2 cm height; 8 lb pull). Once the solvent evaporate and the magnet is removed, the oriented beads are trapped in the Nafion, stacked in pillars normal to the electrode surface. To minimize interbead repulsion, pillars form by stacking the north end of one bead to the south end of another; to minimize interpillar repulsion, the pillars arrange in a roughly hexagonal array. These aligned composites were formed with microbead fractions of $\leq 15\%$. Aligned composites were compared to other composites: unaligned composites—formed as above but with Fe/Fe oxide microbeads and without the magnet; nonmagnetic composites—formed with 1.5 μm nonmagnetic polystyrene beads; simple Nafion films; and demagnetized composites—aligned composites that were demagnetized. Demagnetized composites had the pillared structure, but it is not clear if they were fully demagnetized. Nonmagnetic composites had a coral-like structure (i.e., they do not form pillars). Note, composites may be formed wherein at least one component is reversibly changeable between a paramagnetic form and a diamagnetic form with, for example, a temperature variation and with or without the presence of an externally applied magnetic field.

Other Composites

Similar effects to composites formed with Nafion have been observed using a different polymer and a solvent other than water. One such system is polystyrene sulfonate (PSS) in acetonitrile solvent. The electrolyte is tetraalkylammonium tetrafluoroborate which is different from the inorganic electrolytes that were used in water. Redox probes that have also been used in this system, include $\text{Fe}(\text{bpy})_3^{2+}$ and $\text{Fe}(\text{bpy})_3^{3+}$. Some additional redox species that have been used as probes with these PSS composites (magnets on

electrodes) include Fe(II)bpy₃²⁺, Fe(III)(bpy)₃³⁺, Co(II)(bpy)₃²⁺, and Co(III)(bpy)₃³⁺.

Magnetic Composites

Electrochemical Studies of Magnetic Composites

A composite was equilibrated in a solution of 1 nM electro-active species and 0.1 M electrolyte. The mass transport-limited current for the electrolysis of the redox species through the composite (imeas) was then determined by steady-state rotating disk voltammetry at several different rotation rates (ω). A plot of (imeas') versus $\omega^{-1/2}$ yielded a slope characteristic of transport in solution, and an intercept characteristic of transport through the composite as:

$$\frac{nFA}{i_{meas}} = \frac{v^{1/6}}{0.62c^*D_{sols}^{2/3}}\omega^{-1/2} + \frac{l}{\kappa m \epsilon c^*} \quad (3)$$

in Equation (3), n is the number of electrons, F is the Faraday constant, A is the electrode area, c^* and D_{mols} are the concentration and diffusion coefficient of the redox species in solution, respectively, V is the kinematic viscosity, l is the composite thickness, κ is the partition coefficient of the redox species, m is the mass transport rate of the redox species in the composite, and ϵ is the porosity of the composite. The partition coefficient, κ , is the ratio of the equilibrium concentration in the ion exchange portion of the composite to the solution concentration, in the absence of electrolysis. Equation (3) is appropriate for rate-limiting transport perpendicular to the electrode. This is ensured by choosing l and $D_{mols}^{1/3}\omega^{1/2}v^{1/6}$ large compared to the microstructural dimensions of the composite, and is verified by the slope. Then, the composite can be treated as homogeneous with an effective κm , and microstructural effects can be ascertained with rotating disk studies. Cyclic voltammetry yielded quantitative information for scan rates, v , sufficient to contain the transport length within the composite. For a reversible couple, the peak current i_{peak} is

$$i_{peak} = 0.4463(nF)^{1/2}[v/RT]^{1/2}, \quad (4)$$

where R is the gas constant and T is the temperature. When both rotating disk and cyclic voltammetry data are obtainable, κ and m are separable because of their different power dependencies in Equations (3) and (4).

The flux of redox species through magnetic composites is enhanced in proportion to the absolute value of the difference in the magnetic susceptibilities of the products and reactants of the electrolysis. From cyclic voltammetry, the ΔE_p observed for reversible species, whether paramagnetic or diamagnetic, was little changed, but $E_{0.5}$ was shifted, where $E_{0.5}$ is the average of the anodic and cathodic peak potentials, and is a rough measure of the free energy of the electron transfer reaction. For a quasireversible, diamagnetic species which passed through a radical intermediate, dramatic changes in ΔE_p were found. The shifts and peak splitting were consistent with the stabilization and the concentration of the paramagnetic species. Results are summarized below.

Flux Enhancements for Paramagnetic Species

Values of κm found by rotating disk voltammetry for diamagnetic hydroquinone and Ru(bpy)₃²⁺, and paramagnetic Ru(NH₃)₆³⁺ using Nafion films, nonmagnetic polystyrene microbead composites, and magnetic microbead composites are summarized in Table 2. Both bead composites

contained 15% beads of 1 to 2 μm diameter; all modifying layers were 3.6 to 3.8 μm thick.

TABLE 2

	κm ($10^{-6} \text{ cm}^2/\text{s}$) for Various Magnetic/Nonmagnetic Species and Films		
	$\kappa m_{\text{Nafion film}}$	$\kappa m_{\text{Nonmagnetic}}$	$\kappa m_{\text{Magnetic}}$
Hydroquinone	0.925	1.02	2.21
Ru(bpy) ₃ ²⁺	0.290	0.668	0.869
Ru(NH ₃) ₆ ³⁺	0.570	1.01	3.80

In these examples, as in general, when flux of redox species through the magnetic composite was compared to flux through either Nafion films or composites formed with nonmagnetic beads, the flux was enhanced. In general, we find the flux enhancement is not dependent on whether the electrolysis is converting a diamagnetic to a paramagnetic species or a paramagnetic to a diamagnetic species, but that the enhancement increases as the absolute value of the difference in the molar magnetic susceptibilities of the product and reactant.

To further investigate paramagnetic Ru(NH₃)₆³⁺, κm values were found for magnetic and nonmagnetic composites made with various fractions of beads. Results are shown in FIG. 10. First, in FIG. 10 the flux of Ru(NH₃)₆³⁺ increases strongly with the fraction of magnetic beads, but not with the fraction of nonmagnetic beads. Second, since the enhancement is not linear with the magnetic bead fraction, the enhancement was not due to either a simple concentration increase of the paramagnetic species about each bead or a simple increase in surface diffusion associated with more pillars at higher bead concentration. (Data are equally well linearized with correlation coefficient >0.99 as either $\ln[\kappa m]$ versus percent beads, or κm versus volume of Nafion/surface area of the beads. Plots of both showed intercepts comparable to κm for simple Nafion films.) Third, substantially higher flux was achieved with the magnetic beads than with the same fraction of nonmagnetic beads.

In another series of experiments, composites were formed with magnetic microbeads of similar size, but containing different amounts of magnetic material. In these studies, as magnetic content increased, the values of κm and $\kappa m^{1/2}$ increased. The magnetic content was measured with a Guoy balance and is characterized by x_{bead} (see FIG. 11).

Magnetohydrodynamic models neither account for the discrimination between paramagnetic and diamagnetic species by the magnetic composites, nor do they predict the shape of the curve shown in FIG. 10. Magnetohydrodynamics predicts an effect proportional to the charge on the redox probes. No such dependence is found here.

Electrochemical flux of various redox species from solution through either composites or films to the electrode surface was determined by cyclic and steady-state rotating disk voltammetry. Electrochemical flux of species through the composites is parameterized by κ and m , where κ is the extraction coefficient of the redox species from solution into the composite, and m (cm^2/s) is its effective diffusion coefficient. For steady-state rotating disk voltammetry, the parameterization is κm (determined from the intercept of a Koutecky-Levich plot), and for cyclic voltammetry, the parameterization is $\kappa m^{1/2}$ (extracted from the slope of peak current versus the square root of the scan rate (20 to 200 mV/s)). All measurements were made in solutions containing 1 to 2 mM redox species at a 0.45 cm^2 glassy carbon electrode. The electrolyte was 0.1 M HNO₃, except for the

reduction of $\text{Co}(\text{bpy})_3^{2+}$ (0.2 M Na_2SO_4) and for the oxidation of $\text{Co}(\text{bpy})_3^{2+}$ and reduction of $\text{Co}(\text{bpy})_3^{3+}$ (0.1 M sodium acetate/acetic acid buffer at $\text{pH}=4.5$). Anionic ferricyanide was not detected electrochemically through the anionic Nafion films and composites, consistent with defect-free layers. All potentials were recorded versus SCE (SCE is a standard calomel reference electrode; it has a standard potential of -0.24 V with respect to the reduction potential of hydrogen ions to hydrogen molecule at unit activity).

First, km values were determined for the oxidation of paramagnetic $\text{Ru}(\text{NH}_3)_6^{3+}$ to diamagnetic $\text{Ru}(\text{NH}_3)_6^{2+}$ through magnetic and nonmagnetic composites as the bead fraction was increased. $|\Delta_{\chi_{\text{m}}}|=1,880 \cdot 10^{-6}$ cm^3/moles . From FIG. 10, km for the nonmagnetic composites varies little with bead fraction, while km for the magnetic composites increases superlinearly by several fold.

Second, $\text{km}^{1/2}$ values were determined for various redox reactions for magnetic composites, nonmagnetic composites, and Nafion films. Exclusive of any magnetic field effects, electrochemical flux through Nafion can be altered by the size, charge, and hydrophobicity of the transported species, interaction and binding with the exchange sites, and intercalation into the hydrated and perfluorinated zones of the Nafion. To minimize effects not related to interactions between the redox moieties and the magnetic beads, $\text{km}^{1/2}$ values for the magnetic and nonmagnetic composites are normalized by $\text{km}^{1/2}$ for the Nafion films. The normalized $\text{km}^{1/2}$ values are plotted in FIG. 9 with error bars versus $|\Delta_{\chi_{\text{m}}}|$ for the various redox reactions. FIG. 9 illustrates the relative flux of redox species on the y-axis, where the maximum cyclic voltammetric current for a composite with magnetic microbeads is normalized by the maximum cyclic voltammetric current for a Nafion film containing no magnetic material. The ratio is the flux enhancement. On the x-axis is the absolute value of the difference in the molar magnetic susceptibilities of the products and reactants of the electrolysis, $|\Delta_{\chi_{\text{m}}}|$. The composites contain 15% magnetic microbeads and 85% Nafion by volume. The redox species are numbered as follows, where the reactant products are listed sequentially: (1) hydroquinone to benzoquinone; (2) $\text{Cr}(\text{bpy})_3^{3+}$ to $\text{Cr}(\text{bpy})_3^{2+}$; (3) $\text{Ru}(\text{bpy})_3^{2+}$ to $\text{Ru}(\text{bpy})_3^{3+}$; (4) $\text{Ru}(\text{NH}_3)_6^{3+}$ to $\text{Ru}(\text{NH}_3)_6^{2+}$; (5) $\text{Co}(\text{bpy})_3^{2+}$ to $\text{Co}(\text{bpy})_3^{1+}$; (6) $\text{Co}(\text{bpy})_3^{2+}$ to $\text{Co}(\text{bpy})_3^{3+}$; and (7) $\text{Co}(\text{bpy})_3^{3+}$ to $\text{Co}(\text{bpy})_3^{2+}$. All redox species are 1 mM to 2 mM. Film thicknesses are 3.6 micrometers to 3.8 micrometers. For the nonmagnetic composites, the normalized $\text{km}^{1/2}$ values are independent of $|\Delta_{\chi_{\text{m}}}|$. This suggests the normalization is effective in minimizing steric and electrostatic differences in the interactions of the various redox species with Nafion. For the magnetic composites, normalized $\text{km}^{1/2}$ increases monotonically with $|\Delta_{102, \text{m}}|$, with the largest enhancements approaching 3000%.

The logarithmic increase of electrochemical flux in FIG. 9 with $|\Delta_{\chi_{\text{m}}}|$ is consistent with a free energy effect of a few kJ/mole. Effects of this magnitude have not been generated in uniform, macroscopic magnetic fields. Strong, nonuniform magnetic fields established over short distances (a few nanometers) at the interface between Nafion and magnetic microbeads could produce local effects of this magnitude. Magnetic concepts appropriate to uniform macroscopic magnetic fields and to molecular magnetic interactions are not applicable to this system, and instead, a microscopic parameterization is necessary. Establishing sufficiently strong and nonuniform local magnetic fields at interfaces in microstructured systems makes it possible to orchestrate chemical effects in micro-environments which cannot otherwise be achieved with uniform fields applied by large external magnets.

Cyclic Voltammetric Peak Splittings for Quasireversible Species

Peak splittings in cyclic voltammetry are used to determined heterogeneous electron transfer rates. FIGS. 12A and 12B show cyclic voltammetric results for the reversible species $\text{Ru}(\text{NH}_3)_6^{3+}$ and $\text{Ru}(\text{bpy})_3^{2+}$, respectively. Cyclic voltammograms at 100 mV/s are shown for $\text{Ru}(\text{NH}_3)_6^{3+}$ (FIG. 12A) and $\text{Ru}(\text{bpy})_3^{2+}$ (FIG. 12B) for magnetic composites, Nafion films, and the bare electrode. Cyclic voltammetric results are shown for the reduction of paramagnetic $\text{Ru}(\text{NH}_3)_6^{3+}$ in FIG. 12A. The concentration of the redox species is 1 mM, and the electrolyte is 0.1 M HNO_3 ; the reference is an SCE; and the films are 3.6 μm thick. For both species, when $E_{0.5}$ is compared for the magnetic composite and the Nafion films, the shift in $E_{0.5}$ is to positive potentials. The electron transfer kinetics for $\text{Ru}(\text{NH}_3)_6^{3+}$ are fairly strong with $\kappa^0 > 0.2$ cm/s. Note that the peak splittings for the magnetic composites and Nafion film are similar, consistent with the resistance of the two layers being similar. Similar peak splittings are also observed for $\text{Ru}(\text{bpy})_3^{2+}$, as shown in FIG. 12B. Therefore, when compared to the Nafion films, the magnetic composites have little effect on the rate of electron transfer of reversible species.

In particular, FIG. 12C shows cyclic voltammograms at 100 mV/s for 1 mM hydroquinone in 0.1 M HNO_3 for magnetic composites, nonmagnetic composites, Nafion films, and the bare electrode. The films are 3.6 μm thick. It is observed in the voltammogram of FIG. 12C that the peak splitting is almost doubled for the magnetic composite compared to the Nafion film. The question arises as to whether the enhanced peak splitting is consistent with the stabilization of the paramagnetic semiquinone intermediate in the two electron/two proton oxidation. In FIG. 12C, voltammograms are shown at 0.1 V/s for hydroquinone, a diamagnetic species that undergoes quasireversible, two electron/two proton oxidation to diamagnetic benzoquinone while passing through a radical, semiquinone intermediate. The voltammograms for the Nafion film and the nonmagnetic composites are fairly similar, with ΔE_p values of 218 and 282 mV, respectively. For the magnetic composite, $\Delta E_p=432$ mV, or twice that of the Nafion film. From the results for the reversible couples above, this is not due to a higher resistance in the magnetic composites. The asymmetry in the peak shifts compared to the other three systems shown in FIG. 12C also argues against a resistance effect. (Note that the interpretation of the kinetics can be complicated by the proton concentration. However, there is no reason to think the concentration is drastically different in the magnetic and nonmagnetic composites.) The peak shift may be due to the stabilization of the paramagnetic semiquinone intermediate.

While the hydroquinone electrolysis is too complex to interpret cleanly, it does raise the interesting question of whether quasireversible electron transfer rates can be influenced by an applied magnetic field. Reversible rates will not be affected, but it is not clear what would happen with quasireversible rates. There are many quasireversible electron transfer species uncomplicated by homogeneous kinetics and disproportionation reactions which can be used to better resolve this question. If the kinetics of quasireversible processes can be influenced by magnetic fields, numerous technological systems could be improved. Oxygen reduction by two and four electrons are examples of a system where quasireversible kinetics may be susceptible to alteration by an applied magnetic field gradient.

Cyclic voltammetric Peak Shifts

When magnetic composites and Nafion films are compared, voltammograms taken at 0.1 V/s for the revers-

ible species exhibited no change in ΔE_p . However, the peak potential for reduction, E_p^{red} , for $\text{Ru}(\text{NH}_3)_6^{3+}$ was shifted 14 mV positive. Similarly, the oxidation potential peak, E_p^{ox} , for $\text{Ru}(\text{bpy})_3^{2+}$ was shifted 64 mV positive. Shifts of $E_{0.5}$ while ΔE_p is unchanged are consistent with one species being held more tightly in the composites, and thereby, having a lower diffusion coefficient. In general, a shift in potential of approximately +35 mV is observed for all reversible redox species, whether the electron transfer process converts the redox species from diamagnetic to paramagnetic or paramagnetic to diamagnetic. Larger potential shifts are observed with less reversible electron transfer processes. Shifts as large as 100 mV have been observed. (Note that for the film thicknesses used herein ($\sim 3.6 \mu\text{m}$) and a scan rate of 0.1 V/s, $m \leq 10^{-8} \text{ cm}^2/\text{s}$ is needed for the diffusion length to be confined within the film during the sweep. Since m is not known in these systems, it is not clear whether the voltammetric results also probe behavior at the composite/solution interface.)

The above discussion further shows that interfacial gradients other than concentration and electric potential, e.g., magnetic gradients, can be exploited effectively in microstructured matrices. In composites formed with magnetic materials, locally strong (and nonuniform) magnetic fields could alter transport and kinetics. The influence of the magnetic field on species in composites may be substantial because the species are concentrated in a microenvironment, where the distance between the field source and chemical species is not large compared to the field decay length. Magnetic composites were made by casting films of polystyrene coated magnetic beads and the perfluorinated, cation exchange polymer, Nafion, onto an electrode. Approximately $1 \mu\text{m}$ diameter magnetic beads were aligned by an external magnet as the casting solvents evaporated. Once the solvents evaporated and the external magnet was removed, the beads were trapped in the Nafion, stacked as magnetic pillars perpendicular to the electrode surface.

Preliminary voltammetric studies comparing the magnetic composites to simple Nafion films yielded several interesting results. First, flux of redox species through magnetic microbead composites is enhanced compared to flux through composites formed with nonmagnetic microbeads. Second, for species which underwent reversible electron transfer (i.e., $\text{Ru}(\text{NH}_3)_6^{3+}$ and $\text{Ru}(\text{bpy})_3^{2+}$), the cyclic voltammetric peak potential difference (ΔE_p) was unaffected, but the average of the peak potentials ($E_{0.5}$) shifted consistent with the stabilization of the paramagnetic species. Third, hydroquinone oxidation was quasireversible and proceeded through paramagnetic semiquinone. For hydroquinone at 0.1 V/s, voltammograms for the magnetic composites exhibited at 40 mV positive shift of $E_{0.5}$ and a ΔE_p twice that of Nafion. The potential shifts and flux enhancements, while consistent with concentration and stabilization of the paramagnetic form of the redox couples, are as yet unexplained.

Electrochemical flux of ions and molecules through magnetic composites formed of Nafion ion exchange and polystyrene coated Fe/Fe oxide particles has been observed to be as much as twenty-fold higher than the flux through simple Nafion films. Flux enhancements have been observed with increasing difference in the magnetic susceptibility of the halves of the redox reaction.

A passive, magnetic composite may be used to enhance the flux of oxygen at the cathode in a fuel cell. Oxygen has two unpaired electrons, and is therefore susceptible to this magnetic field in the same way as described in the experiments above. If oxygen is consistent with the observations made thus far for other ions and molecules, the electro-

chemical flux of oxygen to a magnetically modified cathode can be enhanced by approximately 500% as compared to a nonmagnetic cathode (FIG. 13). Such an enhancement would be comparable to that achieved by pressurization to 5 atmospheres at the cathode.

Based on the above discussion, it is possible to predict a roughly five-fold flux enhancement of oxygen through a 15% magnetic/Nafion composite over Nafion. This is understood by considering the fluxes through magnetic/Nafion composites and Nafion films of the seven redox species listed in the upper left hand corner of FIG. 13. These are the same species as listed in FIG. 9. The fluxes were determined by cyclic voltammetry. The flux ratio for magnetic composites to Nafion films is the y-axis and the absolute value of the difference in the molar magnetic susceptibilities ($|\Delta\chi_m|$) of products and reactants of the electrolysis reaction is the x-axis of FIG. 13. (The larger the value of $\Delta\chi_m$, the more susceptible a species is to interaction with a magnetic field.) From FIG. 13, the flux increases exponentially as $|\Delta\chi_m|$ increases. For the most extreme case, the flux is increased about twenty-fold. For the reduction of oxygen to water, $|\Delta\chi_m| \approx 3500 \cdot 10^{-6} \text{ cm}^3/\text{mole}$. This point on the x-axis is extrapolated to therefore suggest that the flux enhancement for oxygen in the magnetic composite will approach five-fold.

Experiments have been conducted with Nafion composites of up to 15% Fe/Fe oxide particle beads. FIG. 14 shows a curve of the increase in flux based on the percentage of magnetic beads. The dotted line on FIG. 14 is the projected effect on flux of higher bead concentrations.

For paramagnetic species, the flux through the magnetic composites increases as the fraction of magnetic beads increases. In FIG. 14, the flux of $\text{Ru}(\text{NH}_3)_6^{3+}$ through magnetic bead/Nafion composites (●) increases as the fraction of magnetic beads in the composite is increased to 15%. Larger enhancements may be possible with higher bead fraction composites or composites formed with magnetic beads containing more magnetic material. Compared to a simple Nafion film (□), the flux is 4.4 fold larger. $\text{Ru}(\text{NH}_3)_6^{3+}$ is less paramagnetic than oxygen. For comparison, composites formed with nonmagnetic polystyrene beads (○) were examined; these exhibited no flux enhancement as the bead fraction increased. The line shown on the plot is generated as a logarithmic fit to the data for the magnetic composites. It illustrates the flux enhancement that might be found for composites formed with a higher fraction of magnetic beads. The extrapolation suggests that at 30% magnetic beads, the flux through the magnetic composites of $\text{Ru}(\text{NH}_3)_6^{3+}$ might approach twenty times its value in simple Nafion films. As oxygen is more paramagnetic than $\text{Ru}(\text{NH}_3)_6^{3+}$ even larger enhancements might be anticipated for oxygen.

Oxygen Susceptibility to Magnetic Composites and Magnetic Concepts

Paramagnetic molecules have unpaired electrons and are drawn into (aligned by) a magnetic field (i.e., a torque will be produced; if a magnetic field gradient exists, magnetic dipoles will experience a net force). Radicals and oxygen are paramagnetic. Diamagnetic species, with all electrons paired, are slightly repelled by the field; most organic molecules are diamagnetic. (Metal ions and transition metal complexes are either paramagnetic or diamagnetic.) How strongly a molecular or chemical species responds to a magnetic field is parameterized by the molar magnetic susceptibility, χ_m (cm^3/mole). For diamagnetic species, χ_m is

between $(-1 \text{ to } -500) \cdot 10^{-6} \text{ cm}^3/\text{mole}$, and is temperature independent. For paramagnetic species, \bar{E}_m ranges from 0 to $+0.01 \text{ cm}^3/\text{mole}$, and, once corrected for its usually small diamagnetic component, varies inversely with temperature (Curie's Law). While ions are monopoles and will either move with or against an electric field, depending on the sign of the potential gradient (electric field), paramagnetic species are dipoles and will always be drawn into (aligned in) a magnetic field, independent of the direction of the magnetic vector. A net force on a magnetic dipole will exist if there is a magnetic field gradient. The magnetic susceptibilities of O_2 , H_2O and H_2O_2 are summarized below.

TABLE 3

Molar Magnetic Susceptibilities, E_m		
Species	Temperature ° K.	$E_m (10^{-6} \text{ cm}^3/\text{mole})$
O_2	293	3449
H_2O	293	-13
H_2O_2	—	-18

Magnetic field effects were observed in electrochemical systems. Because electrochemistry tends to involve single electron transfer events, the majority of electrochemical reactions should result in a net change in the magnetic susceptibility of species near the electrode. Little has been reported, however, in electrochemistry on magnetic fields. What has been reported relates to magnetohydrodynamics. Magnetohydrodynamics describes the motion of the charged species (i.e., an ion) perpendicular to the applied magnetic field and parallel to the applied electric field (Lorentz force). In the composites described herein, the magnetic field, the direction of motion, and the electric field were all normal to the electrode. Because magnetohydrodynamics (see FIGS. 1-3) does not predict a motion dependence on the magnetic susceptibility of the moving species and requires that all the field and motion vectors are perpendicular (i.e., for magnetic effects), the effects described here are unlikely to be macroscopic magnetohydrodynamic effects.

Graded Density Composites

The following protocol is used to form density layers on electrodes with the density layers parallel to the electrode surface or other surface: A solution of a copolymer of sucrose and epichlorohydrin (commercially available as Ficoll and used to make macroscopic graded density columns for separations of biological cells by their buoyancy) are made in water at concentrations varying from a few percent to 50% by weight. The viscosity of the solution is a monotonic function of the weight percent polymer. Small volumes of polymer solution (5 to 100 microliters) are pipetted onto an electrode surface and the electrode spun at 400 rpm for two minutes; this creates a single polymer layer. By repeating this process with polymer solutions of different concentrations, a graded interface with density and viscosity varied as a function of the composition of the casting solution can be created. The thickness of each step in the staircase structure depends on the number of layers cast of a given concentration, and can range from 200 nm to several micrometers.

A similar structure with graded layers of ion exchange sites in ion exchange polymers can be formed by (1) spin casting a mixture of density gradient polymer and ion exchange polymer on the electrode or other surfaces as described above; (2) forming a density graded layer of density gradient polymer first, and then absorbing the ion

exchange polymer into the matrix; or (3) spin coating layers of ion exchange polymers on surfaces from solutions of different concentrations. It should be possible to cast such layers, and then peel them off surfaces to form free standing films. Such films would have utility in controlling solvent transport across electrochemical cells, including fuel cells.

A protocol is proposed to form density layers on electrodes with the density layers perpendicular to the electrode surface or other surface. Electrodes and surfaces can be envisioned in which more than one gradient is established on the surface for purposes of separating molecules in more than one spatial and temporal coordinate and by more than one property. One example is to form composites with a magnetic gradient in one coordinate and a density gradient in the other. These materials could be formed by creating a magnetic gradient perpendicular to the electrode surface by placing magnetic beads on an electrode or surface and allowing the composite to be cast in a nonuniform field, where the external magnet is aligned so the beads are on the surface but not in columns perpendicular to the surface. A density layer could be cast (as opposed to spun coat) by pipetting small volumes of different concentrations of density gradient polymer and/or ion exchange polymer and allowing the solvents to evaporate, thereby building up a graded layer parallel to the electrode surface. Once the entire layer is cast, the external magnet can be removed if the magnetic material is superparamagnetic, and left in place if the magnetic material is paramagnetic.

These would be fairly sophisticated composites, and complex to understand, but unusual flux enhancements and separations should be possible in several dimensions. It should be possible to design even more complex structures than these. For example, embodiments combining two effects such as magnetic field gradient effects with density gradient effects to make a more sophisticated separator to perform multiple separations of somewhat similar materials is possible. This would be an example of an apparatus and method for separating similar things in a mix which involves a graded matrix instead of separate chambers (such as for lighter transition metals and heavier transition metals or other species as discussed below).

Modified Ion Exchangers

The surface of the magnetic microbeads have ion exchange groups on them which would allow ready chemical modification, e.g., coating with a magnetically oriented liquid crystal for a local flux switch. Examples of such modified structures may have use in the quest to build microstructured devices and machines.

Separation of Lanthanides and Actinides

Lanthanides and actinides are the heaviest transition metals having atomic numbers in the ranges 58-71 and 90-103, respectively. The lanthanides and actinides include metals such as plutonium, uranium, and thorium. Various isotopes of these transition metals are radioactive, and either are used as the fissionable material in nuclear reactors or are generated by nuclear decay processes.

Some of the isotopes of lanthanides and actinides (e.g., ^{227}Ac , ^{232}Th , ^{235}U , ^{238}U , ^{231}Pa , ^{237}Np , ^{244}Pu , ^{242}Pu , ^{239}Pu , ^{238}Pu , ^{243}Am , ^{241}Am , ^{244}Cm , ^{242}Cm , ^{249}Bk , and ^{252}Cf) have significant (long) half-lives, and pose a significant environmental remediation problem, especially when the radioactive materials are present in a complex matrix of waste sludge or mine tailings. A most extreme example is the storage vats at Hanford, Wash. Thus, separation of lan-

thanides and actinides is important. Note, separation here means separation of ions and metals rather than isotopes.

The environmental problems could at least be simplified if the heavier transition metals could be removed selectively from the matrix. Even if the separation process simultaneously removes metal species other than the lanthanides and the actinides, the separation would still be advantageous. The separation does not have to be specific, only selective, to be useful. For example, removing the heavier transition metals from the waste sludge greatly reduces the level of radioactive hazard in the remaining sludge. The separated radioactive material would be concentrated and much reduced in volume, and, therefore, easier to contain.

Radioactive isotopes are also employed in various imaging processes, especially for medical diagnosis. These processes typically use isotopes with half-lives of a few days or hours. Therefore, isotopes must be generated either on-site or elsewhere to be shipped and used rapidly. If longer half-life isotopes could be used, some of these constraints might be simplified. Also, better images could be obtained with higher concentrations and stronger emitters of radioactive material. Currently, higher concentrations are not used because the detoxification protocol involves isotope decay in the body, rather than a removal process. Therefore, if a method for removing the heavy transition metals from the body could be developed, the range with respect to the type and concentration of isotopes could be expanded.

Difficulty of Separating Lanthanides and Actinides

All of the prior discussion of FIGS. 10 to 14 apply to the lighter transition metals which have been studied. However, the magnetic notions concerning magnetism discussed so far in relation to FIGS. 10 to 14 (which directly support these notions) may also apply to the heavier transition metals as well. The heavier transition metals (lanthanides and actinides) are expected to have similar properties to the lighter transition metals, only more exaggerated.

The lanthanides and actinides have high nuclear mass, and the differences in the chemistries of these heavier transition metals in either row of the periodic chart is established by the number of electrons in the fourth and fifth f-shells, respectively. However, the f-shell electrons are shielded by the fifth (lanthanide) and sixth (actinide) s- and p-shell electrons, and the chemistries of the metals in each row of heavier transition metals are not highly differentiated.

Although traditional methods for separating metals and metal ions are based on selectively plating the metal ions, or using various chromatographic methods, these methods have not been very successful with lanthanides and actinides. Plating methods are not successful because the reduction potentials of the lanthanides and actinides are all within 200 millivolts of each other. For the lanthanides, the three electron reduction of the trivalent cation to the metal occurs at -2.3 ± 0.1 Volts versus NHE (normal hydrogen electrode—a reference electrode defined to the thermodynamic scale of 0 Volts for proton reduction as is well-known in the art) for all member of the series.

Separations can be achieved by various methods, based on, amongst other things, charge, mobilities, and complex formation with chelating agents. Chromatographic separations can be driven, amongst other things, by charge and mobilities. For heavier transition metals such as lanthanides and actinides, charge-based chromatographic separations will not work because these transition metals all have similar charge and similar reduction potentials, which means that they will have similar charge even after they are all reduced.

The same redox potential means that you cannot selectively reduce or oxidize only some of the species.

Because the lanthanides and actinides form similarly sized ions, the mobilities are all very similar, and species, therefore, cannot be well-separated by mobility. Nonchromatographic separation methods involving chelating methods will also be difficult. For example, as the f-shell electrons are shielded by the s- and p-electrons of the next principal shell, the binding constants of the ions of either series with various chelating agents are very similar, resulting in species not being well-separated by chelation. Therefore, another separation technique for these series, such as magnetic separation, is required.

The response of a molecule or ion to a magnetic field is measured by its molar magnetic susceptibility (χ_m) or equivalently, by its magnetic moment, μ . As the number of unpaired electrons in the species increases, μ increases. The lanthanides and actinides have f-shell electrons, which can contain between 0 and 14 electrons. Therefore, the maximum number of unpaired electrons in the f-shell is 7. The properties of the lighter transition metals in the main body of the periodic table are such that they have only d-shell electrons, which can number as many as 10 with a maximum number of five unpaired electrons. Inherently, therefore, lanthanides and actinides can have higher numbers of unpaired electrons than the transition metals with only d-shell electrons. Thus, lanthanides and actinides can have higher magnetic moments than transition metals from the main body of the periodic table. The higher magnetic moments arise from unpaired electrons and, to some extent, nuclear magnetic moments. The higher magnetic moments, as well as the greater range in oxidation states (prior discussion of paramagnetic and diamagnetic redox species is applicable here) and, thus, magnetic moments, should allow lanthanides and actinides to be separated from the lighter transition metals. In some cases, this separation may require an additional oxidation and/or chelation step.

In particular, if a separation yields a mixture of heavier transition metals and transition metals from the main part of the periodic table (lighter transition metals), a change in oxidation state, achieved by either adding an oxidant or reductant or by electrolysis at an electrode, will change not only the charges (and number of electrons in the d- (for main transition metals) and f-shells (for heavier transition metals)) on the metal ions or their complexes, but it can also change the number of unpaired electrons in the heavier and main transition metals. Because the main transition metals have only 10 d-shell electrons and the heavier transition metals have 14 f-shell electrons, ions, metals and complexes which have at least a few electrons in either the d- or f-shells are likely to have different number of unpaired electrons when electrons are added or removed. This will allow the main transition metals to be separated from the heavier transition metals in a large number of cases.

Plots of magnetic moments for the lanthanides, actinides, and lighter transition metals are appended in FIGS. 14A, 14B, and 14C, respectively, for representative metal ion complexes. FIGS. 14A and 14B were taken, respectively, from pp. 329 and 369 of "Advanced Inorganic Chemistry" by F. A. Cotton and G. Wilkinson, Third Edition, Interscience Publishers, NY, 1972 and incorporated herein by reference. Data for FIG. 14C were taken from pp. 38-239 of "The Magnetic Properties of Transition Metal Complexes" by B. N. Figgis and J. Lewis in "Progress in Chemistry," vol. 6, F. A. Cotton, ed., Interscience Publishers, NY, 1964 and from F. H. Burstall and R. S. Nyholm, J. Chem. Soc., 1952, pp. 3570-3579, both incorporated herein by reference. An

examination of FIGS. 14A–C shows that the magnetic moments for the heavier transition metals are higher than the lighter metals. Clearly, however, there is some overlap of magnetic moments between the different metals. For example, Cr(III), UF_4 , UF_3 , and Pr_2O_3 have similar magnetic moments, as do Cr(II) and PuF_4 . The magnetically-based separation would, therefore, not distinguish very well between these species, and they may be grouped together before and after the separation step. However, additional separation steps involving chelation or electrolysis before a subsequent separation step would certainly remove the lighter transition metals from the heavier ones. Nevertheless, the separation of uranium from plutonium species might be more difficult, because the method may not be sufficiently selective. Additional tuning of the method might improve the separation, or repetitive separations might help. Even without additional improvements, it is at least possible to separate trivalent and tetravalent uranium and plutonium species from species such as iron, for example.

One possible way to separate some heavier transition metal species would be to use the fact that they can form gaseous species and that certain separations lend themselves to the gas phase. For example, separation of the gas UF_6 (uranium hexafluoride) or various isotopes thereof may be accomplished using such a separation technique. Previously, isotopes of uranium were separated by making UF_6 and allowing the gases to diffuse down extremely long tubes. Because of the slight differences in mass, the lighter isotopes got to the end of the tubes first.

It should be noted that temperature could have a very great effect on what drives magnetic separations in general and, in particular, what drives magnetic separations of heavier transition metals. Operation at lower temperature can be a real advantage because magnetic susceptibility (moment) of molecular species increases as reciprocal temperature. Dropping temperature from room temperature to just above freezing increases the magnetic moments about 10% (see the discussion about Curie Temperature above). Perhaps this temperature sensitivity may be exploited with thermal gradients to drive magnetic separations of heavy transition metals and other magnetic species.

It may also be possible to build a sensor based on the temperature sensitivity, including a sensor for hot (radioactive) heavier transition metals. A differentiation of some of the various radioactive species in a mix may be realizable from (1) flux enhancement and (2) temperature increases. Perhaps a combination of flux enhancement and temperature-based magnetic separation could be made with parallel or perpendicular magnetic and thermal gradients.

Achieving Separations

Separations can be thought of in several steps:

1. Species are separated because they have different degrees of interaction with some external agent or force (here, magnetic composites and magnetic fields).
2. If one interaction enhances separations, but it does not achieve complete separation, the process should be repeated to improve separation efficiency (here, it may be necessary to set up a sequence of separation vats and magnetic composite separators).
3. If, after several iterations, separation has been partially successful, but several species are still mixed together, try another separation process on this mixture which have already been refined by the first process (here, this

could be a, for example, a chelation process to bind either the lighter or heavy transition metals, e.g., to selectively precipitate one set or the other, or a plating process might be used, or a change in oxidation states followed by another separation step, based on either magnetic properties or some other properties).

For the present invention, we propose to apply these principles above in conjunction with using magnetic composites to separate lanthanides and actinides from other metal ions and to separate lanthanides and actinides into smaller groups based on their magnetic moments. The behaviour and formation of one class of magnetic composites has been previously outlined above.

Based on the previously demonstrated behavior of these composites with the lighter transition metal complexes, it should be possible to separate the heavy transition metal ions or complexes formed by chelation thereof with organic or inorganic ligands. It may be ions, metals, or metal complexes (charged and uncharged) which can be separated, although ions and organometallic complexes are most likely.

The efficiency of the separation will be prescribed, at least in part, by the magnetic moment of the species separated. In an electrochemically-based process, the efficiency may be dictated by the difference in the magnetic moments of the oxidized and the reduced forms of the species. Two basic separation processes are outlined:

Electrochemical processes in which a magnetic composite controls access of the species in the solution to the electrode.

Magnetochromatographic processes in which a magnetic composite is used as a separation membrane between two vats, where one vat has the mixture to be separated, and the species to be separated passes through the separator to a second vat, where the selectively removed species are collected.

Either of the above processes are possible processes for achieving the separation. Other chromatographic processes, where the carrier is a gas, liquid, solid, or plasma and the stationary phase is any magnetically modified microstructured material, also possibly a gas, liquid/suspension, solid, or plasma, are feasible. Here, the roles of the carrier and the stationary phase are not differentiated and may be switched.

Single step separations are possible either chromatographically or electrochemically. However, in a multistep process, as will most likely be needed, several chambers or vats are set up in sequence as illustrated in FIG. 14D so that the most mobile species will be concentrated in the last vat. Here, the magnetic separator may be either simply chromatographic or it may be a magnetically modified porous electrode that allows flow through the electrode. In FIG. 14D which will be discussed in detail below, the separator lets species A pass through the separator with twice the efficiency of species B. After three separation steps, the concentration of species A is enhanced 8:1 ($[2/1]^3:1$) compared to species B, where species A and B were in equal concentrations initially. The efficiencies of magnetic separators will depend on the magnetic properties of the species being separated as discussed above and should be at least as good as the situation just illustrated. Note that the initial, relative concentrations of the species in the initial mixture, like species A and B, will also play a role.

It may be necessary to add ligands before or after the magnetic separation. Ligands added before separation may change selectivity through a separation membrane, probably for reasons other than magnetic properties. For example, if binding is favored for the lighter transition metal species and they can be bound to form negatively charged lighter tran-

sition metal complexes, these complexes would be excluded from the composites if a positively charged ion exchange polymer, or equivalent positively charged material, were used as the binder to form the composite.

It is also possible to increase the magnetic moment of some transition metal complexes if ligands are used which force the metal center to switch from a low to a high spin electron configuration. Lower magnetic moments can be achieved if the ligands force the metal center into the low spin configuration. Cobalt is the most common example of a species capable of forming low and high spin complexes. However, not all metals have low and high spin configurations.

Ligands may be added after the separation, where selective binding to a ligand would allow the chemistries of the lanthanides and the actinides to be distinguishable from the lighter transition metal species. For example, if large binding constants allow the actinides and the lanthanides to form complexes with large ligands, the lanthanides and actinides might be precipitated selectively from the mixture. Other separation processes are also possible. Magnetic separations involving ligands may be applied to lanthanides and actinides as will be discussed in detail below (see discussion involving FIGS. 16A, 16B, and 16C below).

Applications of the Invention General Applications

FIG. 15A shows a simplified representation which will be used to describe how magnetic microboundaries influence a standard electrochemical process. Here, a substrate **20** with a surface **24** serves as a conductor and hence can electrically conduct like a metal, a semiconductor or a superconductor. Substrate **20** is maintained at a first potential **V1**. Two different phases of materials **30a** and **30b** have two different magnetic fields, i.e., are in two different magnetic phases, phase **1** and phase **2**, and are applied to surface **24** of substrate **20**. Since materials **30a** and **30b** have different magnetic fields, boundary regions **33** have magnetic gradients. Boundary regions **33** are not necessarily sharp or straight, but the magnetic field of material **30a** smoothly changes into the magnetic field of material **30b** according to electromagnetic boundary conditions. Therefore, width t represents an average width of boundaries **33**. Width t should be approximately between a few nanometers to a few micrometers and preferably between one nanometer and approximately 0.5 micrometers. Boundary regions **33** are separated from each other by varying distances and S represents the average of these distances. The effect of varying distances S will be described below.

Particles **M** have a magnetic susceptibility χ_m and are in an electrolyte **40** which is at a potential $\sqrt{2}$ due to an electrode **50**. This makes a potential difference of V between electrolyte **40** and substrate **20** (substrate **20** can effectively act as a second electrode). Boundary regions **33** are paths which can pass particles **M**. Particles **M** are then either driven electrically or via a concentration gradient toward substrate **20**. Once particles **M** reach substrate **20**, they either acquire or lose electrons, thereby turning into particles **N** with magnetic susceptibility χ_n . The absolute value of the difference between the magnetic susceptibilities of phase **1** and phase **2** is a measure of the magnitude of the magnetic gradient in region **33** and will be referred to as the magnetic gradient of boundary region **33**. It will be shown below that the flux of particles **M** increases approximately exponentially with respect to increasing the magnetic gradient of boundary region **33** with materials **30a** and **30b** when compared to the flux without materials **30a** and **30b**. This increase in flux can be over a factor of 35-fold or 3500%

resulting in significant improvements in efficiency of many electrochemical processes.

Specific examples of electrochemical systems where magnets might improve an electrochemical cell or process include: chloralkali processing, electrofluoridation, corrosion inhibition, solar and photocells of various types, and acceleration of electrochemical reactions at the electrode and in the composite matrix. Potential shifts of $E_{0.5}$ are always observed and suggest an energy difference is generated by the magnetic fields and gradients in the composites; generically, this could improve performance of all electrochemical energy devices, including, fuel cells, batteries, solar and photocells. Other applications include sensors including dual sensors for parametric species; optical sensors; flux switching; and controlled release of materials by control of a magnetic field, including release of drugs and biomaterials, or in medical dosing. There may also be applications in imaging and resonance imaging technologies.

Boundaries **33** do not have to be equally spaced and do not have to have equal widths or thicknesses t . Materials **30a** and **30b** can be liquid, solid, gas or plasma. The only restriction is that a boundary **33** must exist, i.e., materials **30a** and **30b** must have two different magnetic fields to create the magnetic gradient within the width t . The magnetic gradient of region **33** can be increased by (1) increasing the magnetic content of the microbeads; (2) increasing the bead fraction in the composite; (3) increasing the magnetic strength of the beads by improving the magnetic material in the beads; and (4) enhancing the field in the magnetic microbeads by means of an external magnet. In general, the flux of particles **M** and **N** is correlated with magnetic susceptibility properties, χ_m and E_n . The above phenomena can be used to improve performance of fuel cells and batteries.

FIG. 15B shows apparatus **80** which corresponds to any of the above discussed embodiments as well as the embodiments shown in FIG. 16 and therefore. Some of the embodiments in their implementation require the presence of a magnetic field such as that produced by electromagnet **70** and some of the embodiments do not require electromagnet **70**. Apparatus **80** corresponds to, for example, some embodiments of the magnetically modified electrode, the fuel cell, the battery, the membrane sensor, the dual sensor, and the flux switch. Electromagnet **70** can be any source of a magnetic field. Electromagnet **70** can also be used in the above discussed methods of forming the composite magnetic materials that require the presence of an externally applied magnetic field. Electromagnet **70** can be controlled by controller **72** to produce a constant or oscillating magnetic field with power supplied by power supply **74**.

An external magnetic field such as could be applied by electromagnet **70** may be useful in various embodiments. Switches and further enhancements might be possible in cases where the external field is concentrated in the magnetic particles. For example, flux switches might be useful, especially as actuated by an external magnet or electromagnet **70** in such applications as: (1) release of materials in medical applications; (2) recollection of hot isotopes in medical imaging applications as explained above; (3) microreactors and separators as a means of mixing—perhaps to control a micronuclear reactor or a heat source driven by hot materials; and (4) providing a re-usable system for cleaning and collecting heavier transition metals in hot storage tanks.

For this last idea, once something is in contact with a hot (radioactive) environment, it becomes a hot item, and is

handled as waste to be stored or cleaned. Since cleaning is a complex issue that is not completely presently understood and since there is a major emphasis on controlling the amount of contact with hot materials, an alternative embodiment might be little heavy transition metal "scrubbers" having located therein magnetic separators, flux switches, and/or other examples of structures described herein. These scrubbers would be jettisoned or dispensed into a radioactive tank (or other environment), allowed to collect the heavy transition metals (radioactive or not), then would be recollected and allowed to release their contents by turning on/off their flux switches. One way the scrubbers could be caused to release their magnetically held materials would be to increase the temperature because magnetic effects are reduced at higher temperatures. The switches would then be reset and the scrubbers repositioned or redispensed to scrub again. There would be no new waste and the scrubbers would provide a collector/cleaner/concentrator.

The scrubbers could be exposed to the species to be collected or the species could be distributed amongst the scrubbers by flowing the species over, through, past, or amongst the scrubbers. Moreover, the scrubbers could be contained in a container, released externally to collect the species to be collected, then be recollected within the container for releasing the collected species, and then be recycled or re-used to collect more of the species. It should be understood that the scrubber idea is not restricted to heavier transition metal applications or storage tanks. For instance, perhaps the scrubbers may be employed to "scrub" or remove uranium ions and salts from mine tailings.

FIG. 16 shows another simplified diagram showing a second manifestation of the above described phenomenon and hence a second broad area of application. Namely, FIG. 16 shows a separator 60 which separates a first solution 62a from a second solution 62b. Here, there is no electrode or conductive substrate 20. Solution 62a has at least two different types of particles M_1 and M_2 with two different magnetic susceptibilities χ_{m1} and χ_{m2} , respectively. Once particles M_1 and M_2 drift into an area near any one of boundaries 33, they are accelerated through the boundaries 33 by the magnetic gradient therein. Here, χ_{m1} is greater than χ_{m2} , which causes the flux of particles M_1 through separator 60 to be greater than the flux of particles M_2 through separator 60. This difference in flux can again be over a factor of 3500%, and may somewhat cancel out any difference in acceleration due to different masses of particles M_1 and M_2 . Consequently, if the above process is allowed to proceed long enough, most of the particles M_1 will have passed through separator 60 before particles M_2 , thereby making first solution 62a primarily made up of particles M_2 and second solution 62b primarily made up of particles M_1 . Note, separation of particles M_1 and M_2 may require some special tailoring of the separator 60 and also depends on how much time is allowed for particles M_1 and M_2 to separate. In an infinite amount of time, both particles M_1 and M_2 may cross separator 60. Particle size may also have a bearing on the ultimate separation of particles M_1 and M_2 by separator 60.

The above discussion with respect to FIG. 16 involves two types of particles, M_1 and M_2 , but the discussion also holds for any number of particles. Consider, for example, solution 62a having particles M_1 , M_2 , M_3 and M_4 with susceptibilities χ_{m1} , χ_{m2} , χ_{m3} and χ_{m4} , respectively. If $\chi_{m1} > \chi_{m2} > \chi_{m3} > \chi_{m4}$, then M_1 would pass more easily through separator 60, followed by M_2 , M_3 and M_4 . The greater the difference between magnetic susceptibilities, the better the separation. Multistep chamber separations employing vari-

ous separators like separator 60 with similar or different properties may also be envisioned as will be discussed below.

The above phenomenon can be used to improve performance of fuel cells and batteries. Other applications include separation technology in general, chromatographic processes—including separation of higher transition metal species (lanthanides and actinides), and photography.

To more particularly illustrate the relevant ideas for the magnetic separation of lanthanides and actinides as previously discussed, further consideration of FIG. 14D is appropriate. FIG. 14D shows a system 950 having a series of vats, i.e., vat 1, vat 2, vat 3, and vat 4 (although any number of vats are possible). Between each of vats 1-4 are magnetic separators with magnetic separator 960 between vat 1 and vat 2, magnetic separator 970 between vat 2 and vat 3, and magnetic separator 980 between vat 3 and vat 4. Magnetic separators 1-4 may be of the same type or each a different type. Any one of magnetic separators 960, 970, or 980 may also be a membrane, a porous electrode, or a magnetically modified electrode. A combination of a porous electrode or a magnetically modified electrode with other types of magnetic separators may be possible.

Species or particles A and B are initially in a mixed state or mixture 990A in vat 1 in FIG. 14D in equal or unequal concentrations. The idea is to separate species or particles A from species or particle B by using the selectivity of the combination of vats 1-4 and magnetic separators 960, 970, and 980 (in some circumstances a single magnetic separator like magnetic separators 960, 970, or 980 and two vats like vats 1-4 may suffice for separating species). The properties of magnetic separators 960, 970, and 980 are such that species or particles A preferentially and selectively pass therethrough. Over time, or by virtue of this selectivity, the concentration of species or particles A increases in vat 4 as the separation proceeds from vat 1 having mixture 990A therein to vat 2 having mixture 990B therein, and then from vat 2 to vat 3 having mixture 990C therein, and then finally from vat 3 to vat 4 having mixture 990D therein. Mixtures 990A, 990B, 990C, and 990D of species or particles A and B become more pure in species or particles A as the separation proceeds from vat 1 to vat 4 with vat 4 having mixture 990D of species or particles A and B most pure in species or particles A.

It is possible that vat 4 may contain species or particles A alone (allowing for other impurities) in mixture 990D and no species or particles B. It is also possible that as the concentration of species or particles A is maximized relative to the concentration of species or particles B in mixture 990D in vat 4, simultaneously the converse may be occurring in mixture 990A in vat 1 as species or particles B are left behind by species or particles A, although this is not required. A variation of how the accumulation of species or particles B in mixture 990A in vat 1 occurs is to have preferential transport of species or particles B from any and all of vats 2-4 toward vat 1. For example, both mixture 990A in vat 1 and mixture 990D in vat 4 may include species or particles A and B initially in some initial concentrations. Due to the properties of magnetic separators 960, 970, and 980 and over a period of time, the concentration of species or particles A increases in mixture 990D in vat 4 while the concentration of species or particles B increases in mixture 990A in vat 1 over their respective initial concentrations. The net transport of species or particles A and B is towards vat 4 from vats 1-3 and towards vat 1 from 2-4, respectively.

FIGS. 16A, 16B, and 16C illustrate possible uses of ligands in the selectivity of a separation. Ligands 995 may

be involved to aid in the selectivity of the separation, whether ligands **995** are used in mixtures **990A–D** or with any component thereof, i.e., species or particles A or B, or they are bound to or used in some way in magnetic separators **960**, **970**, or **980**. FIG. **16A** depicts ligands being used to preferentially aid in the transport of species or particles A from mixture **990A** in vat **1** to mixture **990D** in vat **4**. In vat **1**, ligands **995** form complexes **996** with species or particle A. Complexes **996** are preferentially transported through magnetic separators **960**, **970**, and **980**. Once complexes **996** reach vat **4**, a decoupling of ligands **995** and species or particles A may or may not occur (it is shown to occur in FIG. **16A**). Of course, an alternative embodiment (not shown) would be to have ligands **995** form complexes with species or particles B instead, such complexes preventing species or particles B from being transported from vat **1** having mixture **990A** ultimately to vat **4** having mixture **990D** while species or particles A are so transported.

Another alternative embodiment is shown in FIG. **16B**, wherein ligands **997** are associated with magnetic separators **960**, **970**, and **980** to form complexes **998** with either of species or particle A and B so as to allow only one of these species or particles to be transported from vat **1** to vat **4**. FIG. **16B** illustrates complexes **998** formed with species or particles A that allow transport of species or particles A through magnetic separators **960**, **970**, and **980**. It is understood that any of magnetic separators **960**, **970**, or **980** may instead have associated ligands **997** that form complexes **998** with species or particles B that prevent species or particles B from passing therethrough while species or particles A do so.

FIG. **16C** shows another embodiment wherein lighter transition metals C and heavy transition metals D such as the heavy transition metal lanthanides and actinides are separated from a mixture **990E** in vat **1** that includes other species or particles E. This separation through magnetic separator **960A** leaves mixture **990F** in vat **2**. Once this first separation occurs, heavy transition metals D are then separated from lighter transition metals C with the use of ligands **999A** forming complexes **1000** with either lighter transition metals C or heavy transition metals D (complexes **1000** with heavy transition metals D are shown in FIG. **16C**). In FIG. **16C** complexes **1000** pass through magnetic separator **970A** more easily than the lighter transition metals D, this separation leaving mixture **990G** in vat **3**. In FIG. **16C** magnetic separators **960A** and **970A** are shown separating vat **1** from vat **2** and vat **2** from vat **3**, respectively.

FIG. **16D** shows an alternative embodiment without magnetic separator **970A** or vat **3** having mixture **990G**. In this embodiment starting from mixture **990E** in vat **1**, magnetic separator **960A** separates lighter transition metals C and heavier transition metals D from other species or particles E leaving mixture **990F** in vat **2**. In vat **2** ligands **999C** form complexes **1000A** only with heavy transition metals D. Complexes **1000A** facilitate the precipitation of heavy transition metals D as precipitate **1001** as shown in FIG. **16D**. In this way heavy transition metals D are separated from lighter transition metals C. Note that in facilitating the precipitation of heavy transition metals D as precipitate **1001**, complexes **1000A** may or may not precipitate along with heavy transition metals D (i.e., complexes **1000A** may or may not separate into ligands **999C** and heavier transition metals D while the precipitation is occurring). It is to be understood that other ligands that are different from ligands **999A** or **999C** may be used in addition to ligands **999A** or **999C** to form complexes with lighter transition metals C to aid in the separation of lighter transition metals C from heavier transition metals D, although this is not shown in either FIGS. **16C** or **16D**.

All of the embodiments discussed above in relation to FIGS. **14D**, **16A**, **16B**, **16C**, and **16D** correspond to the embodiments shown in FIGS. **16** and **19** and discussed herein which were also included in the parent application, i.e., copending U.S. application Ser. No. 08/294,797 filed Aug. 25, 1994.

Additional variations of the illustrations involving different configurations of vats, magnetic separators, mixtures, and/or ligands or chelating agents may be envisioned by those skilled in the art. These variations include the use of different magnetic separators between any of the vats, different ligands within each vat forming complexes with particular species or types of species therein, different ligands associated with any of the magnetic separators that form complexes with particular species or types of species, or other vectors or separators in 2 or 3 dimensions, or any other variations that would occur to those skilled in the art.

More complex systems than those illustrated in FIGS. **16A–16D** may be envisioned to separate materials, e.g., combined density gradients, thermal gradients, magnetic composite gradients, etc. (with or without vectorial transport), but not limited thereto. For example, complex matrices may be employed if there exists a mixture having iron species and heavier transition metals therein. In these matrices, by separating according to size and weight, it may be possible to better separate these materials from other materials. After the initial separation, separation of iron from the heavier transition metals would be enhanced in the matrices by specifically adding charge and change of charge with the use of electrolysis. Iron is more readily electrolyzed than the heavier transition metals, so despite being collected in the initial separation with the heavier transition metals, it can be removed by electrolysis to either plate out, or change its number of unpaired electrons so as to change its magnetic moment, whereby it could be separated out on the next step.

In the above discussion with respect to FIGS. **15** and **16**, the greater the number of boundary regions **33** per unit area (i.e., the smaller S), the greater the effects due to the presence of boundary regions **33** macroscopically manifest themselves. S can vary from fractions of a micrometer to hundreds of micrometers. In quantum systems with smaller structures, S is further reduced to less than approximately 10 nm.

Design paradigms are summarized below to aid in tailoring composites for specific transport and selectivity functions:

- Forces and gradients associated with interfaces, which are of no consequence in bulk materials, can contribute to and even dominate the transport processes in composites.
- Increasing the microstructure of composites can enhance the influence of interfacial gradients.
- The closer a molecule or ion is placed to the interface, the stronger the effect of the interfacial field on the chemical moiety. Systems should be designed to concentrate molecules and ions near interfaces.
- The ratio of surface area for transport to volume for extraction parameterizes surface transport.
- Fields in a microstructural environment can be nonuniform, but locally strong.
- Strong but short range electrostatic and magnetic fields are better exploited in microstructured environments than in systems with externally applied, homogeneous fields.
- Vectorial transport is plumbed into microstructured matrices by coupling two or more field or concentration

interfacial gradients, the result being advantageous compared to homogeneous matrices; the largest effects will occur when the gradients are either perpendicular or parallel to each other.

Control of surface dimensionality (fractality) is critical in optimizing surface transport in composites.

Several advantages are inherent in ion exchange composites over simple films. First, composites offer properties not available in simple films. Second, composites are readily formed by spontaneous sorption of the ion exchanger on the substrate. Third, while surfaces dominate many characteristics of monolayers and composites, three-dimensional composites are more robust than two-dimensional monolayers. Fourth, interfaces influence a large fraction of the material in the composite because of the high ratio of surface area to volume. Fifth, composites offer passive means of enhancing flux; external inputs of energy, such as stirring and applied electric and magnetic fields, are not required. Sixth, local field gradients can be exploited in composites because the fields and molecular species are concentrated in a microenvironment where both the decay length for the field and the microstructural feature length are comparable. In some of the composites, the field may be exploited more effectively than by applying an homogeneous field to a cell with an external source.

SPECIFIC EXAMPLES

Fuel Cells

It would be very beneficial to achieve high efficiency compressor/expander power recovery technology. One way to improve the efficiency of the compressor/expander would be to reduce the pressure requirement. If a passive pressurization process could be provided within a fuel cell itself, at no cost to the power output of the fuel cell, power production from present day fuel cells would be increased by approximately 20%.

Magnetically modified cathodes may reduce the need for pressurization as oxygen is paramagnetic. The field may also alter oxygen kinetics as discussed below. Potential shifts of +35 mV to +100 mV represent a 5% to 15% improvement in cell efficiency with a comparable savings in weight and volume. Also, in fuel cells, as hydrated protons cross the cell, the cathode floods and the anode dehydrates. Water transport may be throttled by composite separators of graded density and hydration.

In addition to the probability of enhancing flux at a magnetically modified electrode, oxygen reduction kinetics in the case of fuel cells may be altered. The kinetics for oxygen reduction are outlined here:

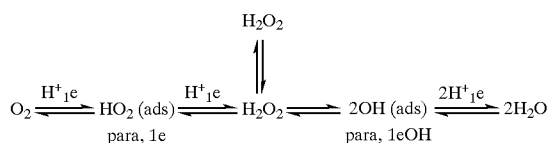

There is a difficulty with the oxygen reduction kinetics that arises, in large part, because H_2O_2 (peroxide) desorbs as peroxide in solution, and does not dissociate on the catalyst surface to form 2OH . Peroxide is not paramagnetic, but HO_2 and OH are paramagnetic. However, the presence of a magnetic field will tend to stabilize the HO_2 , slowing the formation of peroxide. Once adsorbed peroxide is formed, the magnetic field will shift the equilibria in a direction that favors the formation of 2OH . This should drive a larger fraction of the reacting molecules toward the formation of

water, where the full potential of oxygen reduction can be realized as discussed above in regard to E°_{cathode} for water formation and $E^\circ_{\text{HO}_2}$. For these reasons, oxygen will be susceptible to the enhancements that have been observed from other similar paramagnetic species as discussed above.

It may also be important to make a fuel cell with little or no thermal signature, especially in an environment, where, for instance, a minimal thermal signature would be beneficial. Fuel cells are operated at temperatures approaching 100°C . to improve kinetic efficiency. While this temperature is much lower than the temperatures of other refuelable power sources such as internal combustion engines (about 400°C .), 100°C . is still hotter than the human body (about 37°C .) or ambient temperature. However, if kinetic efficiency is improved by a magnetically modified cathode, then fuel cell operating temperatures can be lowered toward ambient temperature without substantial effect on power output. Also, magnetic effects will be larger at lower temperatures. A fuel cell mounted on highly thermal conductive materials, like materials used on the Space Shuttle, might be a way to maintain its temperature closer to body or ambient temperature. Note that although a reduced thermal signature and a reduced operating temperature may be desirable for a fuel cell, there may be an optimal operating temperature for the fuel cell based on performance enhancements, and the method of reducing the thermal signature may have to be accommodating thereof.

The following summarizes some of the salient advantages and features of an ambient pressure PEM fuel cell in operation according to the instant invention:

Reduces the weight of the fuel cell system by removing the compressor pumps;

Reduces the size of the fuel cell system by removing compressor pumps and reduces the size of the fuel cell stack required to reach the same output power;

Allows the production of fuel cells that are $\frac{3}{8}$ inches thick and as flexible as a plastic transparency;

Increases the efficiency of the fuel cell system by 20%;

Increases the voltage—may be driven by a positive shift in the cathode potential or improved kinetics associated with shorter lifetimes of H_2O_2 adsorbed on the electrode surface with the reaction equilibria shifted toward formation of OH ;

Reduces the likelihood of system failure by removing all mechanical parts, i.e., removing mechanical pumps;

Lowers operating temperature—reduces the thermal signature by improving the performance at lower operating temperatures; fuel cells are normally run at higher temperatures to improve the oxygen reduction kinetics, but if kinetic enhancement occurs, then the fuel cell operating temperature can be lowered without a net performance reduction; magnetic effects are larger at lower temperatures which may increase the flux of oxygen even greater and, therefore, make up for performance deficits associated with lower fuel cell operating temperature;

Is scalable—can be used with the same effect on any size fuel cell stack; and

Increases the mean time between failures (MTBF) of the power system by removing mechanical pumps.

It is important to recall that all these effects are occurring at the same time that the need for compressor pumps are removed. Also, if the potential shift or kinetic enhancement are not realized to their fully anticipated degree, then the fuel cell will still operate more efficiently with the flux enhancement that is produced. The minimum result will be a fuel cell

that operates at the same performance level of current fuel cells without the added weight of the compressor pumps and the 15% parasitic power loss associated with running the pumps.

In a PEM fuel cell (or in any other apparatus requiring an electrode described herein or otherwise) it may also be beneficial to tailor the electrode-magnetic composite interface for electrical conductivity. For example, the direct coating of the magnetic beads of the composite with platinum or any other conductor, or semiconductor, or superconductor may significantly increase electrical conductivity of the interface over a random mixing of fixed quantities of carbon and platinum (or any other conductor, or semiconductor, or superconductor, hereinafter referred to simply as platinum) with magnetic beads. It would then be possible to test and evaluate oxygen reduction at magnetically and electrically modified electrodes made with platinum-coated magnetic microbeads mixed with carbon.

Platinum coating of the beads could be accomplished by sputtering platinum on the beads or by any means known in the art. The oxygen reduction results of the directly coated bead system would be compared to oxygen reduction at electrodes made by mixing carbon and platinum powder with magnetic beads, and a determination would be made as to whether platinum-coated beads offer significant enhancement over the simple mixture. To optimize the magnetic bead fraction and platinum content, the point at which increasing the platinum content does not significantly increase oxygen reduction would be determined, as well as the point at which increasing the magnetic bead content (fraction) does not increase flux or becomes unstable. All the above results would be compared to similar results obtained for platinum electrode-magnetic composite interfaces.

Another revolutionary aspect of an ambient pressure PEM fuel cell is the opportunities that it opens up in packaging design. Currently, PEM fuel cells must be encased within a rigid structure in order to contain the pressure applied to the cathode side of the fuel cell. But, the ambient pressure fuel cell increases the flux of oxygen without an external pressurization requirement. This means that the rigid outer encasement is no longer needed.

PEM fuel cells are inherently flexible. The cell itself consists of an anode and cathode separated by an ion exchanger (usually, but not restricted to, Nafion). A fuel cell with a magnetically modified cathode as discussed above which draws air into the cathode from the atmosphere without compression could be formed with an outside covering similar to the porous vegetable bags made of polyethylene or similar polyalkene or other polymer comprised of a hydrocarbon material. Or the fuel cell could be confined to different geometries and volumes, and may be flattened again for use or can be used in the confined geometry. Or the nonpressurized cell could have thin plastic outer surfaces and would be approximately as flexible as an overhead transparency.

The cell would be thin and flexible, about the size of an 8.5x11 inch piece of paper. While consuming a very small volume of fuel, this would provide more than enough power to run laptop or notebook computers with or without color displays. Laptops and notebooks are currently designed to run on approximately 30 Watts. The fuel cell could be used to run a wide variety of portable electronic devices, such as voice and message communications, GPS devices, navigation systems, cameras, etc. A fuel cell with no mechanical pumps, able to sustain good cathode performance could replace batteries in many systems where small, light-weight, flexible, adaptive power sources are needed.

Another possible embodiment of fuel cells could involve forming an array of fuel cells. For example, in a single sheet **1210** of fuel cells **1220**, one of the advantages is that single sheet **1210** can contain several fuel cells **1220** thereon. By configuring fuel cells **1220** in different serial **1200A** and parallel **1200B** arrangements (see FIG. 16E), fuel cell sheet **1210** can be used to meet a wide variety of different power demands. For example, single fuel cell sheet **1210** can substitute for a wide range of different batteries. If single sheet **1210** were divided into, for example, 9 small cells of 1 Volt and 25 Amps each, the cells can be connected in different ways. If the nine cells are connected in series, the system will produce 9 Volts and 25 Amps; if the cells are connected in parallel, they will produce 1 Volt and 225 Amps; and if the cells are connected as a series connection of three sets of three cells in parallel, they will produce 3 Volts and 75 Amps.

Oxygen Concentrators

Another possible application of magnetically modified electrodes or cathodes involving flux enhancement of oxygen relates to the more general problem of the concentration of oxygen from the air. The concentration of oxygen in this case amounts to separating oxygen from nitrogen. This problem may be solved using the magnetically modified electrode or cathode technique or other separation techniques discussed above and herein. Currently, the separation of oxygen from air is done cryogenically which is a costly undertaking. In a magnetic membrane system where the membrane is placed between ambient (~20% oxygen in air) air and an inner vat (or volume), and the oxygen is immediately swept from the inner vat, a concentration gradient of oxygen is established across the membrane, and oxygen is preferentially drawn into the inner volume from the ambient air.

Membrane Sensors

Membrane sensors for the paramagnetic gases O₂, NO₂, and NO (recently identified as a neurotransmitter) could be based on magnetic composites where enhanced flux would reduce response times and amplify signals. Sensors for other analytes, where oxygen is an interferant, could distinguish between species by using dual sensors, identical except one sensor incorporates a magnetic field. Examples of these sensors could be optical, gravimetric, or electrochemical, including amperometric and voltammetric. In sensors, the measured signal is proportional to the concentration of all species present to which the sensor responds. The presence of a magnetic component in the sensor will enhance sensitivity to paramagnetic species. Through a linear combination of the signal from two sensors, similar in all respects except one contains a magnetic component, and the sensitivity of the magnetic sensor to paramagnetic species (determined by calibration), it is possible to determine the concentration of the paramagnetic species. In a system where the sensors are only sensitive to one paramagnetic and one diamagnetic species, it is possible to determine the concentration of both species.

Flux Switches

As nanostructured and microstructured materials and machines develop into a technology centered on dynamics in microenvironments, flux switches will be needed. Externally applied magnetic fields can actuate flux switches using electrodes coated with composites made of paramagnetic polymers and Fe/Fe oxide or Fe particles or other non-

permanent magnetic material, or internal magnetic fields can actuate flux switches using electrodes coated with composites made of electro-active polymers or liquid crystals, where one redox form is diamagnetic and the other is paramagnetic, and organo-Fe or other superparamagnetic or ferrofluid materials or permanent magnetic or aligned surface magnetic field material. Also, an external magnet can be used to orient paramagnetic polymers and liquid crystals in a composite containing paramagnetic magnetic beads. Enhanced orientation may be possible with magnetic beads containing superparamagnetic or ferrofluid materials.

As discussed above, flux switches may be important for the little scrubber designs. They may also be important for delivery of drugs, biomaterials or medical dosing in a living organism, where an external or internal magnetic field may turn on/off a flux switch to enable delivery thereof. Flux switches may also be important in imaging applications as already discussed.

As an extension of the concept of passive oxygen pressurization of fuel cell cathodes, the more general problem of concentration of oxygen from the air may be similarly solved. Currently, this is done cryogenically which is a costly undertaking. Essentially, this type of oxygen concentration involves the separation of O₂ from N₂ using the magnetically modified electrode and separation techniques discussed above.

Batteries

Batteries with increased current densities and power, as well as decreased charge and discharge times may be made with magnetic bead composites. The improvement would be driven by flux enhancement, transport enhancement, electron kinetic effects, or by capitalizing on a potential shift. The required mass of microbeads would little affect specific power. Since magnetic field can suppress dendrite formation, secondary battery cycle life may be extended. (Note that suppression of dendrite formation may also be important in plating dense films of lanthanides and actinides.)

The main mechanism of failure for rechargeable batteries is the formation of dendrites. Dendrites are conducting deposits that build-up between the two electrodes in the battery during cycling which will eventually short out the cell. It has been shown in tests that an externally applied magnetic field can suppress dendrite formation.

Therefore, an improved battery may include magnetically modified or coated electrodes that prevent or suppress dendrite formation. The magnetic coatings may be on the electrodes or elsewhere in the battery structure. As discussed above, a magnetic field can be established directly at the electrode surface by modifying the electrode surface with a composite of ion exchanger (polymeric separator) and magnetic particles, eliminating the need for a large external electromagnet to provide the necessary magnetic field (although in certain circumstances an externally applied magnetic field may be desirable or useful). Modifying the electrode produces a negligible increase in cell weight (<1%). Also, the flux of ions and molecules through these composites is enhanced substantially compared to the flux through the separator alone.

Using magnetic composites in rechargeable battery systems, three potential and significant improvements in battery performance are anticipated:

1. Cycle life will be enhanced because of the suppression of dendrite formation due the magnetic field at the surface of the electrodes;

2. Recharge time will be decreased (recharge rate increased) by as much as ten-fold due to the flux enhancements; and
3. Transient power output will be higher by as much as ten-fold and the discharge of power will be more rapid due to the flux enhancements.

The charging time is decreased and the transient power is increased to the extent that the motion of ions and molecules in the cell limits performance. A ten-fold (and possibly higher in some cases) enhancement in ion and molecule motion has already been demonstrated in the magnetic composites.

In a protracted use situation, the cycle life of a battery will be important. Cycle life will be enhanced by establishing a magnetic field at the electrode surface. As cycle life has not been tested with the composites of the type already discussed, it is not yet clear how much it would be improved. However, a few-fold improvement in cycle life is likely. The technological advantages that will be seen include:

1. A negligible increase in size and weight (<1%), approximately 5-6 lbs;
2. The simplicity of modifying and the compatibility with existing battery technology; and
3. An insignificant cost of materials to change current battery technology (a few cents per battery).

The electrode modification should be useful in a wide variety of battery types, including zinc and copper batteries. In these battery types an externally applied magnetic field has demonstrated suppression of zinc and copper deposit dendrite formation.

To demonstrate the suppression of dendrite formation, an electrode must first be modified with a magnetic composite. Once the electrode is available, dendrite formation suppression is tested with the electrode in solution. Such tests provide a ready method for examining the feasibility of magnetic composites in a wide variety of battery systems.

Tests are then performed to test the magnetic composites in a two electrode battery system. The fraction of the magnetic particles needed is optimized and the depth of the separator that should contain magnetic particles is determined. Then an evaluation of cycle life, charging time, discharging time, power transients, weight change, size change, and cost is made for comparison with a system containing no magnetic particles. Once a cell is constructed using magnetically modified electrodes that shows improvements in cycle life, charging time, and power transients, the long term stability of the cell is an issue that must also be evaluated.

The process just described can be used to create a battery that is light-weight, more efficient, and a longer lasting power source than conventional batteries with unmodified electrodes. This, coupled with a greatly increased power output, will allow the operation of apparatus requiring battery power for extended periods of time. Also, more equipment may be operated with this battery at one time than with a conventional battery.

Methods of Making the Electrode

FIG. 17 is a short summary of steps involved in a method of making an electrode according to two embodiments of the invention. In one embodiment, the method is a method of making an electrode with a surface coated with a magnetic composite with a plurality of boundary regions with magnetic gradients having paths to the surface of the electrode according to one embodiment of the invention. In particular step 702 involves mixing a first component which includes

a suspension of at least approximately 1 percent by weight of inert polymer coated magnetic microbeads containing between approximately 10 percent and approximately 90 percent magnetizable polymer material having diameters at least about 0.5 micrometers in a first solvent with a second component comprising at least approximately 2 percent by weight of ion exchange polymer(s) in a second solvent to yield a mixed suspension. Step **708** then involves applying the mixed suspension to the surface of the electrode. The electrode is arranged in a magnetic field of at least approximately 0.05 Tesla, wherein the magnetic field has a component oriented approximately along the normal of the electrode surface and preferably is entirely oriented approximately along the normal of the electrode surface. Step **714** then involves evaporating the first solvent and the second solvent to yield the electrode with a surface coated with the magnetic composite having a plurality of boundary regions with magnetic gradients having paths to the surface of the electrode.

Step **702** can include mixing the first component which includes a suspension of between approximately 2 percent and approximately 10 percent by weight of inert polymer coated magnetic microbeads with the second component. Alternatively, step **702** can include mixing the first component which includes inert polymer coated magnetic microbeads containing between 50 percent and 90 percent magnetizable polymer material with the second component. Alternatively, step **702** can include mixing the first component which includes inert polymer coated magnetic microbeads containing 90 percent magnetizable polymer material with the second component.

In addition, step **702** can include mixing a first component which includes a suspension of at least approximately 5 percent by weight of inert polymer coated magnetic microbeads containing between approximately 10 percent and approximately 90 percent magnetizable polymer material having diameters ranging between approximately 0.5 micrometers and approximately 12 micrometers. Alternatively, step **702** can include mixing a first component which includes a suspension of at least approximately 5 percent by weight of inert polymer coated magnetic microbeads containing between approximately 10 percent and approximately 90 percent magnetizable polymer material having diameters ranging between approximately 1 micrometer and approximately 2 micrometers.

Mixing step **702** can also involve mixing a first component which includes a suspension of at least approximately 5 percent by weight of inert polymer coated magnetic microbeads containing between approximately 10 percent and approximately 90 percent magnetizable polymer material having diameters at least 0.5 micrometers in a first solvent with a second component of at least approximately 5 percent by weight of Nafion in a second solvent to yield the mixed suspension.

Step **702** can involve mixing a first component which includes a suspension of at least approximately 5 percent by weight of inert polymer coated magnetic microbeads containing between approximately 10 percent and approximately 90 percent organo-Fe material having diameters at least 0.5 micrometers in a first solvent with a second component of at least approximately 5 percent by weight of ion exchange polymer(s) in a second solvent to yield the mixed suspension.

Step **708** can include applying approximately between 2 percent and approximately 75 percent by volume of the mixed suspension to the surface of the electrode.

Alternatively, step **708** can include applying between 25 percent and 60 percent by volume of the mixed suspension to the surface of the electrode. In yet another approach step **708** can involve applying the mixed suspension to the surface of the electrode, the electrode being arranged in a magnetic field between approximately 0.05 Tesla and approximately 2 Tesla and preferably the magnetic field is approximately 2 Tesla.

An alternative embodiment involving steps **702'** through **714'** (also shown in FIG. 17) involves the use of an external magnetic field. That is, again the method of making an electrode with a surface coated with a composite with a plurality of boundary regions with magnetic gradients having paths to the surface of the electrode when the external magnetic field is turned on. The steps **702** through **714** are then modified into steps **702'** through **714'** as follows. Step **702'** involves mixing a first component which includes a suspension of at least 5 percent by weight of inert polymer coated microbeads containing between 10 percent and 90 percent magnetizable non-permanent magnetic material having diameters at least 0.5 micrometers in a first solvent with a component solution of at least 5 percent of ion exchange polymers in a component solvent to yield a mixed suspension. Step **708'** then involves applying the mixed suspension to the surface of the electrode. Step **714'** involves evaporating the first solvent and the second solvent to yield the electrode with a surface coated with the composite having a plurality of boundary regions with magnetic gradients having paths to the surface of the electrode when the external magnet is turned on.

FIGS. **18A** and **18B** show a flux switch **800** to regulate the flow of a redox species according to yet another embodiment of the invention. In particular, FIGS. **18A** and **18B** show an electrode **804** and a coating **808** on the electrode **804**. Coating **808** is formed from a composite which includes magnetic microbead material **812** with an aligned surface magnetic field to an ion exchange polymer **816**; and an electro-active polymer **820** in which a first redox form is paramagnetic and a second redox form is diamagnetic, wherein the flux switch is actuated by electrolyzing the electro-active polymer from the first redox form ordered in the magnetic field established by the coating to the second redox form disordered in the magnetic field.

Microbead material **812** can include organo-Fe material. The redox species can be more readily electrolyzed than the electro-active polymer. Electro-active polymer **820** can be an electro-active liquid crystal with chemical properties susceptible to said magnetic field or an electro-active liquid crystal with viscosity susceptible to said magnetic field. Electro-active polymer **820** includes an electro-active liquid crystal with phase susceptibility to said magnetic field. Electro-active polymer **812** can include poly(vinyl ferrocenium). In addition, in a preferred embodiment the flux switch further comprises an externally applied magnetic field, and said magnetic microbead material comprises organo-Fe material.

FIG. **19** shows a dual sensor **900** for distinguishing between a first species (particles A) and a second species (particles B). The dual sensor includes a first membrane sensor **912** which preferentially passes the first species over the second species; and a second membrane sensor **906**, which preferentially enhances the concentration of the second species over the first species, thereby enabling the measurement of at least the first species. The first and second species can be in any state such as liquid, gaseous, solid and plasma.

In one embodiment, the first species can include a paramagnetic species and the second species can include a

diamagnetic species. In this case, the first membrane sensor **906** is a magnetically modified membrane sensor, an the second membrane sensor **912** is an unmodified membrane sensor. The magnetically modified membrane sensor preferentially enhances the concentration of and allows the detection of the paramagnetic species over the diamagnetic species and the unmodified membrane sensor enhances the concentration of and allows the detection of the diamagnetic species and the paramagnetic species, enabling the measurement of the concentration of at least the paramagnetic species. More particularly, the paramagnetic species can be one of O₂, NO₂, and NO. The diamagnetic species can be CO₂.

In another embodiment, the first species can include a paramagnetic species and the second species can include a nonmagnetic species. In this case, the first membrane sensor **906** is a magnetically modified membrane sensor, and the second membrane sensor includes an unmodified membrane sensor. The magnetically modified membrane sensor preferentially enhances the concentration of and allows the detection of the paramagnetic species over the nonmagnetic species and the unmodified membrane sensor enhances the concentration of and allows the detection of the nonmagnetic species and the paramagnetic species, thereby enabling the measurement of the concentration of at least the paramagnetic species. More particularly, the paramagnetic species can be one of O₂, NO₂, and NO.

In yet another embodiment, the first species can include a diamagnetic species and the second species can include a second diamagnetic species. In this case, the first membrane sensor **906** is a magnetically modified membrane sensor, and the second membrane sensor **912** is a differently magnetically modified membrane sensor. The magnetically modified membrane sensor preferentially enhances the concentration of and allows the detection of the first diamagnetic species over the second diamagnetic species and the differently magnetically modified membrane sensor enhances the concentration of and allows the detection of the second paramagnetic species and the diamagnetic species, enabling the measurement of the concentration of at least the first diamagnetic species. The first diamagnetic species can include CO₂.

In yet another embodiment, the first species can be a first paramagnetic species and the second species can be a second paramagnetic species. In this case, the first membrane sensor **906** is a magnetically modified membrane sensor, and the second membrane sensor **912** is a differently magnetically modified membrane sensor, wherein the magnetically modified membrane sensor preferentially enhances the concentration of and allows the detection of the first paramagnetic species over the second paramagnetic species and the differently magnetically modified membrane sensor enhances the concentration of and allows the detection of the second paramagnetic species and the first paramagnetic species, enabling the measurement of the concentration of at least the first paramagnetic species. Again, the first paramagnetic species is one of O₂, NO₂, and NO.

In yet another embodiment of the invention, the first species can be a diamagnetic species and the second species can be a nonmagnetic species. In this case, the first membrane sensor **906** is a magnetically modified membrane sensor, and the second membrane sensor **912** is an unmodified membrane sensor, wherein the magnetically modified membrane sensor preferentially enhances the concentration of and allows the detection of the diamagnetic species over the nonmagnetic species and the unmodified membrane sensor enhances the concentration of and allows the detec-

tion of the nonmagnetic species and the diamagnetic species, enabling the measurement of the concentration of at least the diamagnetic species.

FIG. **20** shows a cell **201** according to another embodiment of the invention. In particular, FIG. **20** shows an electrolyte **205** including a first type of particles. A first electrode **210** and a second electrode **215** are arranged in electrolyte **205**. The first type of particles transform into a second type of particles once said first type of particles reach said second electrode **215**. Second electrode **215** has a surface with a coating **225** fabricated according to the above methods. Coating **225** includes a first material **230** having a first magnetism, and a second material **234** having a second magnetism, thereby creating a plurality of boundaries (**33** of FIG. **15A**) providing a path between said electrolyte **205** and said surface of said second electrode **215**. Each of said plurality of boundaries having a magnetic gradient within said path, said path having an average width of approximately one nanometer to approximately several micrometers, wherein said first type of particles have a first magnetic susceptibility and said second type of particles have a second magnetic susceptibility and the first and said second magnetic susceptibilities are different. Coating **225** operates in the manner described with respect to FIG. **16**.

First material **230** in coating **225** can include a paramagnetic species and said second material **234** can include a diamagnetic species. Alternatively, first material **230** can include a paramagnetic species having a first magnetic susceptibility and the second material **234** can include a paramagnetic species having a second magnetic susceptibility, and said first magnetic susceptibility is different from said second magnetic susceptibility. In yet another approach, said first material **230** can include a diamagnetic species having a first magnetic susceptibility while said second material **234** includes a diamagnetic species having a second magnetic susceptibility and said first magnetic susceptibility is different from said second magnetic susceptibility. In another approach, the first material **230** could alternatively include a paramagnetic species having a first magnetic susceptibility and said second material **234** comprises a nonmagnetic species. In another approach, said first material **230** can include a diamagnetic species having a first magnetic susceptibility and said second material **234** can include a nonmagnetic species. The electrolyte can be an electrolyzable gas such as O₂ or can include a chlor-alkali.

Chromatographic Flux Enhancement by Nonuniform Magnetic Fields

Using a chromatographic approach, as discussed above, flux may be enhanced by nonuniform magnetic fields. This is a separation or chromatographic application (magnetochemistry) and it involves no electrochemistry. The idea for the invention follows below.

The basic methodology comprises taking an iron (or other magnetizable material) wire and coating it to make it chemically inert. The iron wire is threaded inside a capillary. The capillary is filled with a polymer or other material through which molecules and/or ions can move. Alternatively, the polymer or other material can be dip coated or cast directly in the surface of the inert coating; this eliminates the need for the capillary. The ions and/or molecules to be separated are introduced into one end of the capillary. A gradient is established along the length of the tube to cause motion of the ions through the tube. The gradient could be a concentration or a potential gradient. (There is a whole range of gradients used in chromatography that can be directly

drafted into this system. Besides concentration and potential gradients, these include gradients of density, viscosity, pressure, temperature, ion exchange capacity, characteristic dimensions of the microstructured substrate (stationary phase) polarity and dielectric constant, as well as forced flow and convection, and time dependency (temporary gradients and pulses)). The capillary is placed inside a magnetic field. A circular magnet could be used, but other geometries are possible. The magnetic field will be concentrated inside the iron wire, and as the field decays into the polymer gel surrounding the wire, a nonuniform magnetic field will be established. Moieties moving through the gel will be drawn toward the wire and swept down the tube by the concentration gradient and surface diffusion processes.

Variations in specific embodiments are possible. A wire is discussed above, but any shape including beads will work. The wire can be any magnetizable material such as iron or iron oxides, as well as permanent magnets and superconductors.

The coating on the wire to make it chemically inert could include polymers, silanes, thiols, silica, glass, etc. In some systems, the choice of wire, solvent and substrate may create a system where the "wire" is already inert and no coating is needed.

The polymer or gel in the capillary can be one of the ion exchange polymers already discussed (Nafion and polystyrene sulfonate) or other material, probably needing some viscosity higher than bulk solvent. Other examples could involve separation materials commonly used in chromatography—including acrylamide polymers, acrylate polymers, Dow-Ex (Trademark of Dow-Corning Corporation) materials, or maybe just sucrose or glycerol (glycerin) in solvent.

Ions and/or molecules can be introduced from any phase (gas, liquid, solid, or plasma), although liquid is the most obvious. Molecules can be introduced continuously for a continuous separation or in single shots or in a series of shots. The nonmagnetic gradient is needed to pull molecules that move into the surface zone rapidly down the tube so more molecules can be drawn in by the magnetic field.

The concentration of the field inside a magnetizable wire or other structure by the external magnet can be controlled with pulsed fields, reversed fields, DC fields, and graded fields as only some examples of what can be done to control the separation and transport direction (vector) of the materials. A combination of different magnetizable materials inside the gel—either parallel or crossed, might provide some interesting mechanisms for vectoring molecules and separating things by the susceptibilities. Note, the combination of vectors provides a mechanism for separations of all types.

Note also that the switching possibilities here are significant. By using an external electromagnet in this system, it should be possible to turn the effect on and off. If superconductors are used, the switching can be done by turning the field on and off by temperature changes.

All the existing separation methodologies of chromatography and separation science can be brought to bear here. Separations are driven by various gradients and flows. These include diffusion, migration, fluid flow, size exclusion, thermal programming, electrophoresis, electro-osmosis, etc.

An embodiment of the above discussed chromatographic technique is shown in FIG. 20A. FIG. 20A shows apparatus 1100 comprising capillary 1110, magnets 1120, iron wire 1130, polymer gel 1140, solvent 1150, and species 1160. FIG. 20B shows rough magnetic field lines that may be

concentrated in iron wire 1130. Species 1160 is to be separated from other species introduced through one end of capillary 1110. Species 1160 is fed into one end of capillary or tube 1110 containing solvent 1150 and caused to move through capillary or tube 1110 driven by a gradient (concentration, potential, or other gradient) and is subsequently passed through or is swept down capillary 1110 or through polymer gel 1140 therein mitigated by its own magnetic properties (magnetic susceptibility) and the magnetic field concentrated in iron wire 1130 by magnets 1120. Thereafter, species 1160 is collected after passing through the other end of capillary or tube 1110 and separated from other species not passing through capillary 1110.

A method comprising steps for this chromatographic process may be described in FIG. 20C as follows. In step 1170 an iron wire is coated to make it chemically inert. The iron wire is then threaded inside a capillary or tube in step 1172A. A capillary is filled with a polymer, gel, or other material (may be viscous) through which molecules and/or ions can move in step 1172B. Alternatively, the inert wire is dip coated or cast with a polymer, gel, or other material (may be viscous) directly in step 1173. The inert wire is placed inside a magnetic field in step 1176 with or without the capillary, depending on the previous alternative steps. A gradient is established along the length of the tube to carry the mobile the species (including species to be separated) down the tube in step 1178. Species with the highest magnetic susceptibilities (including the species to be separated) are pulled into the interface between the inert coating and the polymer, gel, or other material (viscous matrix), the facile transport zone of the interface which enhances the flux of the magnetically susceptible species in step 1180. In step 1180, species move through the interface between polymer or other materials and the inert coating through which molecules and/or ions can move and are swept down the tube by the gradient and surface diffusion processes according to the magnetic properties of the species, the magnetic field concentrated in the iron wire, and the magnetic gradient established in the system from the iron wire and the external field.

Another method that could be follows for the apparatus involves: placing an iron wire (or other material) into a heat shrink material in step 1310, perhaps Teflon; heat shrinking the heat shrink material in step 1320; dip coating with a layer of Nafion or PSS; drying it, perhaps in a vacuum desiccator in step 1330; capping the ends of the coated wire and sliding the coated wire into tubing, perhaps spaghetti tubing in step 1340; placing one end of the tubing in a solution that contains the species to be separated in step 1350; placing the other end of the tubing into a solution that contains species to be separated (this sets up a concentration gradient down the length of the tubing) in step 1360; placing the entire system in a magnetic field that is set up radially with respect to the iron wire, perhaps in a hollow cylindrical magnet in step 1370. This process will enhance the separation of paramagnetic species. Note that the wire may be made of other material than iron, such as permanent magnets. The wire may also be in different geometries than a typical wire, such as a plate, disk, or any other shape or volume.

Numerous and additional modifications and variations of the present invention are possible in light of the above teachings. It is therefore to be understood that within the scope of the appended claims, the invention may be practiced otherwise than as specifically claimed.

What is claimed is:

1. A separator for separating a first type of particle, comprising a transition metal particle having a first magnetic susceptibility, from a second type of particle having a second magnetic susceptibility, comprising:

- a first material having a first magnetism;
- a second material having a second magnetism, wherein said first and second materials are arranged to form a microstructured magnetic composite material;

said microstructured magnetic composite material comprising a plurality of boundaries between the first and second materials that are adapted to provide paths through the microstructured magnetic composite material, each of said plurality of boundaries having a magnetic gradient within said plurality of paths, wherein, when said microstructured magnetic material is placed in a region containing the first and second types of particles, the magnetic gradients cause at least some of the first type of particles to be separated from said region while inhibiting the separation of a majority of the second type of particles from said region.

2. The separator as claimed in claim 1, wherein said microstructured magnetic composite material is adapted to separate lanthanide particles from said region when said microstructured magnetic composite material is placed in said region.

3. The separator as claimed in claim 1, wherein said microstructured magnetic composite material is adapted to separate actinide particles from said region when said microstructured magnetic composite material is placed in said region.

4. The separator as claimed in claim 1, wherein said microstructured magnetic composite material is adapted to separate heavy transition metal particles from said region when said microstructured magnetic composite material is placed in said region.

5. The separator as claimed in claim 1, wherein said microstructured magnetic composite material is adapted to separate light transition metal particles from said region when said microstructured magnetic composite material is placed in said region.

6. The separator as claimed in claim 1, wherein said microstructured magnetic composite material is adapted to inhibit the separation of lanthanide particles from said region when said microstructured magnetic composite material is placed in said region.

7. The separator as claimed in claim 1, wherein said microstructured magnetic composite material is adapted to inhibit the separation of actinide particles from said region when said microstructured magnetic composite material is placed in said region.

8. The separator as claimed in claim 1, wherein said microstructured magnetic composite material is adapted to inhibit the separation of heavy transition metal particles from said region when said microstructured magnetic composite material is placed in said region.

9. The separator as claimed in claim 1, wherein said microstructured magnetic composite material is adapted to inhibit the separation of light transition metal particles from said region when said microstructured magnetic composite material is placed in said region.

10. The separator as claimed in claim 1, wherein said microstructured magnetic composite material is adapted to separate a radioactive species from said region when said microstructured magnetic composite material is placed in said region.

11. The separator as claimed in claim 1, wherein said microstructured magnetic composite material is adapted to

inhibit the separation of radioactive species from said region when said microstructured magnetic composite material is placed in said region.

12. The separator as claimed in claim 1, wherein said microstructured magnetic composite material further comprises a ligand that is adapted to form complexes with said transition metal particle when said microstructured magnetic composite material is placed in said region.

13. The separator as claimed in claim 1, wherein said microstructured magnetic composite material further comprises a ligand that is adapted to form complexes with said second type of particle when said microstructured magnetic composite material is placed in said region.

14. The separator as claimed in claim 1, wherein said microstructured magnetic composite material further comprises a ligand that is adapted to form complexes with one of said first and second types of particles when said microstructured magnetic composite material is placed in said region.

15. The separator as claimed in claim 1, wherein said microstructured magnetic composite material further comprises a ligand that is adapted to form complexes with said first type of particles that aid in the separation of said first type of particles from said region when said microstructured magnetic composite material is placed in said region.

16. The separator as claimed in claim 1, wherein said microstructured magnetic composite material further comprises a ligand that is adapted to form complexes with said second type of particles that help suppress the separation of said second type of particles from said region when said microstructured magnetic composite material is placed in said region.

17. The separator as claimed in claim 1, wherein said microstructured magnetic composite material is adapted to separate more of said first type of particles from said region when a thermal gradient is established in said microstructured magnetic composite material.

18. A system, comprising:

- a transition metal species with a first magnetic susceptibility;

- a second species with a second magnetic susceptibility; and

- a microstructured magnetic composite material comprising a first material having a first magnetism, and a second material having a second magnetism, and a plurality of boundaries between the first and second materials that provide paths through the microstructured magnetic composite material, wherein said microstructured composite material is adapted to separate said transition metal species from said second species.

19. The system as claimed in claim 18, when said transition metal species comprises a lanthanide.

20. The system as claimed in claim 18, when said transition metal species comprises an actinide.

21. The system as claimed in claim 18, when said transition metal species comprises a heavy transition metal.

22. The system as claimed in claim 18, when said transition metal species comprises a light transition metal.

23. The system as claimed in claim 18, when said second species comprises a lanthanide.

24. The system as claimed in claim 18, when said second species comprises an actinide.

25. The system as claimed in claim 18, when said second species comprises a heavy transition metal.

26. The system as claimed in claim 18, when said second species comprises a light transition metal.

51

27. The system as claimed in claim 18, when said transition metal species comprises a radioactive species.

28. The system as claimed in claim 18, when said second species comprises a radioactive species.

29. A system for separating lanthanides and actinides with different magnetic susceptibilities, comprising:

- a first magnetic material with a first magnetism; and
- a second magnetic material with a second magnetism, wherein said first and second materials are arranged to form a microstructured magnetic composite material having a plurality of boundaries between the first and second materials that provide paths through the microstructure magnetic composite material, each of said plurality of boundaries having a magnetic gradient within said plurality of paths

wherein said magnetic gradients separate said lanthanides and said actinides when said microstructured magnetic composite material is placed in a region containing said lanthanides and actinides.

30. A separator for separating a first type of particle having a first magnetic susceptibility from a second type of particle having a second magnetic susceptibility, comprising:

- a polystyrene sulfonate ion exchange polymer having a first magnetism;
- a second material having a second magnetism, wherein said polystyrene sulfonate and said second material are arranged to form a microstructured magnetic composite material;

52

said microstructured magnetic composite material comprising a plurality of boundaries between said polystyrene sulfonate and said second material that are adapted to provide paths through the microstructured magnetic composite material, each of said plurality of boundaries having a magnetic gradient within said plurality of paths, wherein, when said microstructured magnetic material is placed in a region containing the first and second types of particles, the magnetic gradients cause at least some of the first type of particles to be separated from said region while inhibiting the separation of a majority of the second type of particles from said region.

31. The separator as claimed in claim 30, further comprising a solvent, said solvent comprising acetonitrile.

32. The separator as claimed in claim 30, further comprising an electrolyte, said electrolyte comprising tetraalkylammonium tetrafluoroborate.

33. The separator as claimed in claim 30, wherein said microstructured magnetic composite material is adapted to separate $\text{Fe}(\text{bpy})_3^{3+}$ particles from $\text{Fe}(\text{bpy})_3^{2+}$ particles when said microstructured magnetic composite material is placed in said region.

* * * * *